

WIRING DUCT (OPEN SLOT)

Unit:mm

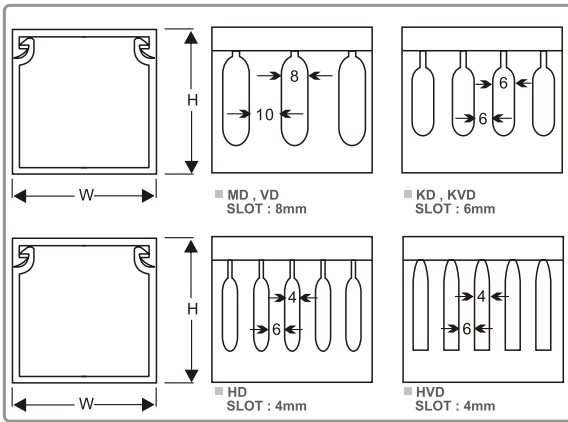
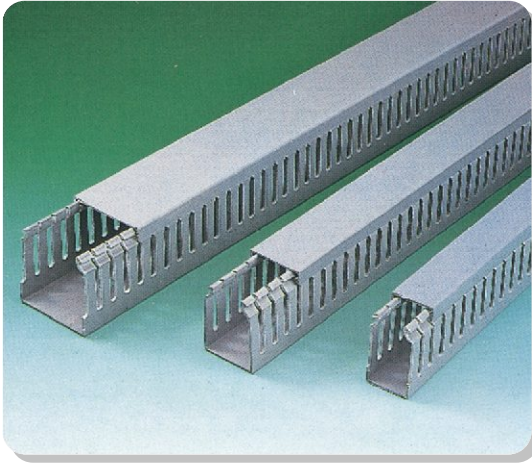

SLOT: 8mm for all applicable size except for MD-6.5L, MD-6.7L, MD-8L in 10mm. (100mm in high)

- Material: High impact, self-extinguishing, warp-proof PVC(Polyvinyl chloride), UL approved 94V-0
- Color: Gray.
- Maximum service temperature: 85°C.
- UL test up to 50°C.
- These devices are for routing of wires within devices in factory installations where the suitability of use will be determined by UL during the end user investigation.
- Parallel holes on both sidewalls to facilitate cutting in wire application.
- Special color, size, length upon request at reasonable quantity.

FIXING SLOT

For width:
25mm, 33mm,
40mm, 45mm,
50mm, 60mm,
65mm

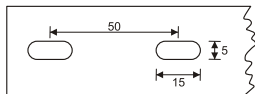

■ AVAILABLE AT 100mm SLOT UPON REQUEST.

For width:
72mm, 80mm,
100mm, 150mm,
200mm

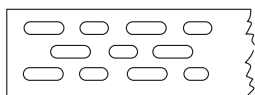

ITEM NO.			DIMENSION W x H	WIRES TO BE CONTAINED (2mm ²)	LENGTH
SLOT					
8mm	6mm	4mm			
MD-0.5L		HD-0.5L	15 x 25	5-12pcs	2M
MD-0.7L		HD-0.7L	20 x 20	5-12pcs	
MD-0L		HD-0L	25 x 25	10-25pcs	
MD-1L	KD-1L	HD-1L	25 x 45	20-25pcs	
MD-1.1L		HD-1.1L	30 x 30	15-25pcs	
MD-1.2L	KD-1.2L	HD-1.2L	33 x 33	25-45pcs	
MD-1.5L	KD-1.5L	HD-1.5L	33 x 45	40-55pcs	
MD-2L	KD-2L	HD-2L	45 x 45	60-70pcs	
MD-2.2L		HD-2.2L	50 x 50	80-90pcs	
MD-2.5L	KD-2.5L	HD-2.5L	65 x 45	110-120pcs	
MD-3L	KD-3L	HD-3L	33 x 65	60-75pcs	
MD-4L	KD-4L	HD-4L	25 x 65	40-45pcs	
MD-5L	KD-5L	HD-5L	45 x 65	110-120pcs	
MD-5.5L	KD-5.5L	HD-5.5L	60 x 60	120-135pcs	
MD-5.7L	KD-5.7L	HD-5.7L	65 x 65	180-200pcs	
MD-6L			72 x 64	200-220pcs	
MD-6.5L		HD-6.5L	33 x 100	180-200pcs	
MD-6.6L			37.5 x 100	180-200pcs	
MD-6.7L	KD-6.7L	HD-6.7L	48 x 100	215-250pcs	
MD-6.8L			55 x 100	220-260pcs	
MD-6.9L			75 x 75	200-250pcs	
MD-7L			70 x 100	250-300pcs	
MD-7.1L			75 x 100	260-320pcs	
MD-7.2L			100 x 50	200-250pcs	
MD-7.5L			100 x 75	260-320pcs	
MD-8L	KD-8L	HD-8L	100 x 100	300-400pcs	
MD-9L			120 x 75	280-380pcs	
MD-10L			150 x 75	335-500pcs	
MD-12L			150 x 100	450-600pcs	
MD-15L			200 x 100	600-800pcs	
MD-21L			200 x 150	1040-1200pcs	
MD-22L			200 x 200	1200-1600pcs	
MD-30L			300 x 100	1040-1200pcs	

Unit:mm

ITEM NO.			DIMENSION W x H	WIRES TO BE CONTAINED (2mm ²)	LENGTH
SLOT					
8mm	6mm	4mm			
VD-1		HVD-1	25 x 30	15-25pcs	2M
VD-1.5		HVD-1.5	30 x 30	15-25pcs	
VD-2		HVD-2	25 x 40	20-25pcs	
VD-3		HVD-3	33 x 40	40-45pcs	
VD-4	KVD-4	HVD-4	40 x 40	60-70pcs	
VD-5		HVD-5	60 x 40	100-115pcs	
VD-5.5		HVD-5.5	80 x 40	120-135pcs	
VD-5.7		HVD-5.7	100 x 40	130-175pcs	
VD-6		HVD-6	25 x 60	40-45pcs	
VD-7	KVD-7	HVD-7	40 x 60	100-115pcs	
VD-8	KVD-8	HVD-8	60 x 60	120-135pcs	
VD-9		HVD-9	80 x 60	180-210pcs	
VD-9.5		HVD-9.5	100 x 60	240-290pcs	
VD-9.6		HVD-9.6	120 x 60	240-290pcs	
VD-9.65		HVD-9.65	120 x 65	260-360pcs	
VD-9.66		HVD-9.66	25 x 80	100-120pcs	
VD-9.7		HVD-9.7	40 x 80	120-135pcs	
VD-9.8		HVD-9.8	60 x 80	180-210pcs	
VD-10		HVD-10	80 x 80	240-290pcs	
VD-10.5		HVD-10.5	100 x 80	260-350pcs	
VD-11		HVD-11	120 x 80	300-400pcs	
VD-12		HVD-12	40 x 100	130-175pcs	
VD-13		HVD-13	60 x 100	240-290pcs	
VD-14		HVD-14	80 x 100	260-350pcs	

Nylon Cable Tie, Wiring Accessories

Quick Fitting, Terminal,
Copper Tube Terminal

Crimping Tool, Hydraulic Tool

WIRING DUCT(SOLID)

Unit:mm

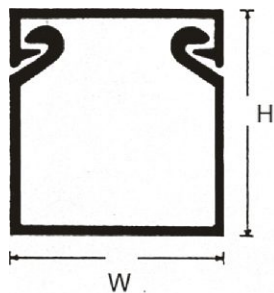
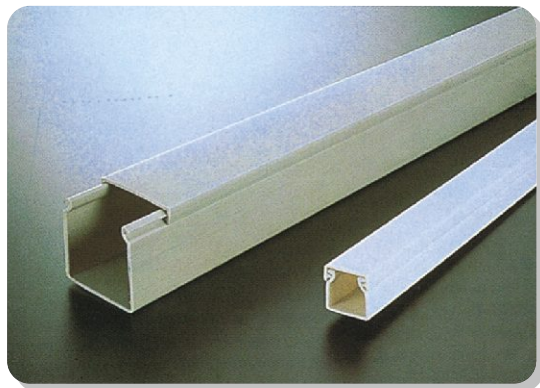

SOLID: Without slot , for external wiring or where wire extraction is not necessary.

- Material: High impact, self-extinguishing, warp-proof PVC, UL approved 94V-0
- Color: Gray.
- Maximum service temperature: 85°C.
- These devices are for routing of wires within devices in factory installations where the suitability of use will be determined by UL during the end user investigation.
- Special color, size, length upon request at reasonable quantity.

ITEM NO.	W x H	WIRES TO BE CONTAINED (2mm ²)	LENGTH
SD-33100	33 x 100	180-200 pcs	2M
SD-37100	37.5 x 100	180-200 pcs	
SD-40100	40 x 100	130-175 pcs	
SD-48100	48 x 100	215-250 pcs	
SD-50100	50 x 100	210-260 pcs	
SD-55100	55 x 100	220-260 pcs	
SD-60100	60 x 100	240-290 pcs	
SD-70100	70 x 100	250-300 pcs	
SD-75100	75 x 100	260-350 pcs	
SD-80100	80 x 100	260-350 pcs	
SD-100100	100 x 100	300-400 pcs	
SD-150100	150 x 100	450-600 pcs	
SD-200100	200 x 100	600-800 pcs	
SD-200150	200 x 150	1040-1200 pcs	
SD-200200	200 x 200	1200-1600 pcs	
SD-300100	300 x 100	1040-1200 pcs	

ITEM NO.	W x H	WIRES TO BE CONTAINED (2mm ²)	LENGTH
SD-2210	22 x 10	3-8 pcs	2M
SD-3015	30 x 15	10-25 pcs	
SD-1616	16 x 16	3-10 pcs	
SD-2516	25 x 16	5-12 pcs	
SD-3816	38 x 16	12-30 pcs	
SD-2020	20 x 20	5-12 pcs	
SD-4020	40 x 20	20-40 pcs	
SD-1525	15 x 25	5-12 pcs	
SD-2525	25 x 25	10-25 pcs	
SD-3825	38 x 25	20-40 pcs	
SD-5025	50 x 25	25-45 pcs	
SD-2530	25 x 30	15-25 pcs	
SD-3030	30 x 30	20-40 pcs	
SD-3333	33 x 33	25-45 pcs	
SD-10030	100 x 30	130-160 pcs	
SD-10033	100 x 33	180-200 pcs	
SD-3838	38 x 38	45-50 pcs	
SD-2540	25 x 40	20-25 pcs	
SD-3340	33 x 40	40-45 pcs	
SD-4040	40 x 40	60-70 pcs	
SD-6040	60 x 40	100-115 pcs	
SD-7540	75 x 40	120-135 pcs	
SD-8040	80 x 40	120-135 pcs	
SD-10040	100 x 40	180-200 pcs	
SD-2545	25 x 45	20-25 pcs	
SD-3345	33 x 45	40-55 pcs	
SD-4545	45 x 45	60-70 pcs	
SD-6545	65 x 45	110-120 pcs	
SD-2550	25 x 50	20-30 pcs	
SD-3850	38 x 50	20-35 pcs	
SD-5050	50 x 50	80-90 pcs	
SD-7550	75 x 50	180-200 pcs	
SD-8050	80 x 50	180-200 pcs	
SD-10050	100 x 50	200-250 pcs	
SD-2560	25 x 60	40-45 pcs	
SD-4060	40 x 60	100-115 pcs	
SD-6060	60 x 60	120-135 pcs	
SD-8060	80 x 60	180-210 pcs	
SD-10060	100 x 60	240-290 pcs	
SD-12060	120 x 60	240-290 pcs	
SD-7264	72 x 64	200-220 pcs	
SD-2565	25 x 65	40-45 pcs	
SD-3365	33 x 65	60-75 pcs	
SD-4565	45 x 65	110-120 pcs	
SD-6565	65 x 65	180-200 pcs	
SD-12065	120 x 65	260-350 pcs	
SD-2575	25 x 75	50-55 pcs	
SD-3775	37.5 x 75	110-115 pcs	
SD-5075	50 x 75	180-200 pcs	
SD-7575	75 x 75	200-250 pcs	
SD-10075	100 x 75	260-320 pcs	
SD-12075	120 x 75	280-380 pcs	
SD-15075	150 x 75	335-500 pcs	
SD-2580	25 x 80	60-75 pcs	
SD-4080	40 x 80	120-135 pcs	
SD-6080	60 x 80	180-210 pcs	
SD-8080	80 x 80	240-290 pcs	
SD-10080	100 x 80	260-350 pcs	
SD-12080	120 x 80	300-400 pcs	

Nylon Cable Tie, Wiring Accessories

Quick Fitting Terminal, Copper Tube Terminal

Crimping Tool, Hydraulic Tool

WIRING DUCT CUTTER

ITEM NO. : WT-1

ITEM NO. : WT-2



TELEPHONE WIRING DUCT (SELF-ADHESIVE)

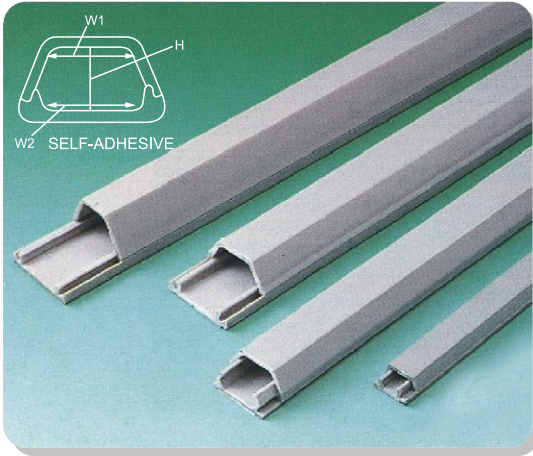

- Material: High impact, self-extinguishing, warp-proof PVC. Backed with high quality self-adhesive tape to facilitate wire application.
- Color: Gray.(Milk,white,brown available upon request)
- Length: 1M.(2M available upon request)
- Application: Designed to protect wire on floor.

Unit:mm

ITEM NO.	LENGTH	DIMENSIONS			WIRES TO BE CONTAINED (2mm ²)	PACKING
		W1	W2	H		
TD-1	1M	6	7	4	1pcs	200pcs
TD-2	1M	8	10	6	2-3pcs	100pcs
TD-3	1M	10	11	7	3-4pcs	100pcs
TD-4	1M	12	15	10	4-7pcs	100pcs
TD-5	1M	10	17	13	7-9pcs	100pcs
TD-6	1M	11	18	16	10-15pcs	50pcs
TD-8	1M	30	37	16	30-40pcs	50pcs

ROUND TYPE WIRING DUCT (SELF-ADHESIVE)



- Material: High impact, warp-proof PVC, self-extinguishing, UL approved 94V-0.
- Maximum service temperature: 85°C
- Color: Gray (Brown, Milky, Light grained, Dark Grained available on request).
- Backed with high quality double sided tape for permanent stick. Good for floor wiring to facilitate trolley pass and to avoid tumbling.
- Special grooves design to avoid slip. Shining cover facilitates for decoration and is suitable for department store, supermarket, shopping mall, station, hotel, hospital, office and any other public area.

Unit:mm

CONNECTOR COVER CONNECTOR BASE



CONNECTOR COVER TYPE	
MID-WAY CONNECTOR	RDM-20
"L" TYPE	RDL-20
OUTSIDE CORNER	RDO-20
INSIDE CORNER	RDI-20
"T" TYPE	RDT-20
END PIECE	RDE-20

CONNECTOR BASE TYPE	
"L" TYPE	RBL-60
"T" TYPE	RBT-20

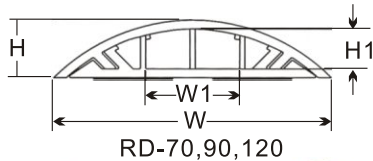
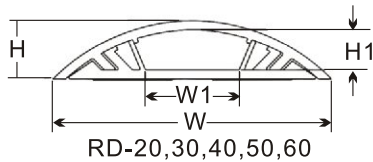

ITEM NO.		W	W1	H	H1	LENGTH	Connector cover Item NO.	Connector base Item NO.
RD-20	Gray	20	8	6	4	1M With Adhesive Tape	RDT-20,RDM-20 RDI-20,RDO-20 RDL-20,RDE-20	RBL-20 RBT-20
RD-20BN	Brown							
RD-20MW	Milky							
RD-20LX	Light grained							
RD-20DX	Dark grained							
RD-30	Gray	30	11	8	6		RDT-30,RDM-30 RDI-30,RDO-30 RDL-30,RDE-30	RBL-30 RBT-30
RD-30BN	Brown							
RD-30MW	Milky							
RD-30LX	Light grained							
RD-30DX	Dark grained							
RD-40	Gray	40	16	9.5	7		RDT-40,RDM-40 RDI-40,RDO-40 RDL-40,RDE-40	RBL-40 RBT-40
RD-40BN	Brown							
RD-40MW	Milky							
RD-40LX	Light grained							
RD-40DX	Dark grained							
RD-50	Gray	50	20	11	8		RDT-50,RDM-50 RDI-50,RDO-50 RDL-50,RDE-50	RBL-50 RBT-50
RD-50BN	Brown							
RD-50MW	Milky							
RD-50LX	Light grained							
RD-50DX	Dark grained							
RD-60	Gray	60	30	13	9	RDT-60,RDM-60 RDI-60,RDO-60 RDL-60,RDE-60	RBL-60 RBT-60	
RD-60BN	Brown							
RD-60MW	Milky							
RD-60LX	Light grained							
RD-60DX	Dark grained							
RD-70	Gray	70	40	15	10	RDT-70,RDM-70 RDI-70,RDO-70 RDL-70,RDE-70	RBL-70 RBT-70	
RD-70B	NBrown							
RD-70MW	Milky							
RD-70LX	Light grained							
RD-70DX	Dark grained							
RD-90	Gray	90	45	19	15	RDT-90,RDM-90 RDI-90,RDO-90 RDL-90,RDE-90	RBL-90 RBT-90	
RD-90BN	Brown							
RD-90MW	Milky							
RD-90LX	Light grained							
RD-90DX	Dark grained							
RD-120	Gray	120	70	25	21	RDT-120,RDM-120 RDI-120,RDO-120 RDL-120,RDE-120	RBL-120 RBT-120	
RD-120BN	Brown							
RD-120MW	Milky							
RD-120LX	Light grained							
RD-120DX	Dark grained							

CABLE TIE



Details in E244153

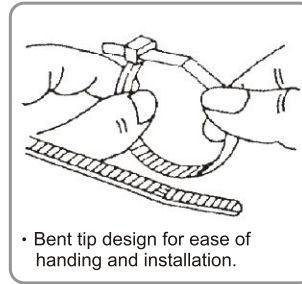

- Material: UL approved Nylon 66 , UL 94V-2 (94V-0, UV black, heat resistance available).
- Working Temp: -40°C to 85°C (-40°F to 185°F).
- Color: stock in natural (Black, Yellow, Red, Orange, Green, Blue, Purple, Gray available upon request with reasonable quantity).
- Packing: 100pcs/polybag

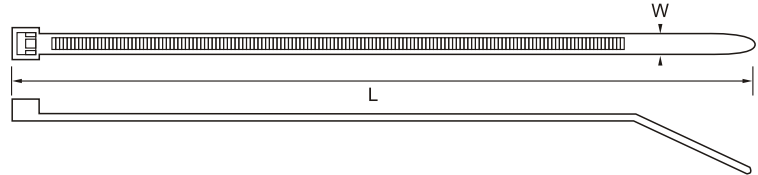

Nylon Cable Tie, Wiring Accessories

Quick Fitting Terminal, Copper Tube Terminal

Crimping Tool, Hydraulic Tool

ITEM NO.			L		W	MAX.BUNDLE	MIN.TENSILE STRENGTH		PACKING PER CARTON
NATURAL	BLACK	UV	mm	inch	mm	mm	lbs(kgs)	CLASS	
GT-75M	GT-75M-BK	GT-75M-UV	75	3"	2.4	15	18 (8)	MINIATURE	60,000PCS.
GT-80M	GT-80M-BK	GT-80M-UV	80	3 1/8"	2.4	16	18 (8)		60,000PCS.
GT-100M	GT-100M-BK	GT-100M-UV	100	4"	2.5	22	18 (8)		60,000PCS.
GT-120M	GT-120M-BK	GT-120M-UV	120	4 3/4"	2.5	28	18 (8)		50,000PCS.
GT-140M	GT-140M-BK	GT-140M-UV	142	5 1/2"	2.5	35	18 (8)		35,000PCS.
GT-150M	GT-150M-BK	GT-150M-UV	155	6 1/8"	2.5	39	18 (8)		35,000PCS.
GT-160M	GT-160M-BK	GT-160M-UV	165	6 1/2"	2.5	43	18 (8)		35,000PCS.
GT-200M	GT-200M-BK	GT-200M-UV	203	8"	2.5	55	18 (8)		28,000PCS.
GT-250M	GT-250M-BK	GT-250M-UV	250	10	2.5	68	18 (8)		28,000PCS.
GT-300M	GT-300M-BK	GT-300M-UV	300	11 7/8"	2.5	83	18 (8)		12,000PCS.
GT-400M	GT-400M-BK	GT-400M-UV	400	15 3/4"	2.5	116	18 (8)	12,000PCS.	
GT-120I	GT-120I-BK	GT-120I-UV	120	4 3/4"	3.2	27	40 (18)	INTERMEDIATE	32,000PCS.
GT-140I	GT-140I-BK	GT-140I-UV	142	5 1/2"	3.2	34	40 (18)		25,000PCS.
GT-200IS	GT-200IS-BK	GT-200IS-UV	203	8"	3.2	52	40 (18)		22,000PCS.
GT-150I	GT-150I-BK	GT-150I-UV	150	6"	3.6	36	40 (18)		23,000PCS.
GT-180I	GT-180I-BK	GT-180I-UV	180	7"	3.6	46	40 (18)		17,000PCS.
GT-200I	GT-200I-BK	GT-200I-UV	203	8"	3.6	52	40 (18)		17,000PCS.
GT-250I	GT-250I-BK	GT-250I-UV	250	10"	3.6	68	40 (18)		15,000PCS.
GT-270I	GT-270I-BK	GT-270I-UV	265	10 1/2"	3.6	73	40 (18)		15,000PCS.
GT-300I	GT-300I-BK	GT-300I-UV	292	11 1/2"	3.6	82	40 (18)		15,000PCS.
GT-330I	GT-330I-BK	GT-330I-UV	330	13"	3.6	93	40 (18)		13,000PCS.
GT-370I	GT-370I-BK	GT-370I-UV	368	14 1/2"	3.6	105	40 (18)	12,000PCS.	
GT-200ST	GT-200ST-BK	GT-200ST-UV	203	8"	4.6	52	50 (22)	STANDARD	13,000PCS.
GT-250S	GT-250S-BK	GT-250S-UV	250	10"	4.6	65	50 (22)		12,000PCS.
GT-280S	GT-280S-BK	GT-280S-UV	280	11"	4.6	75	50 (22)		12,000PCS.
GT-300S	GT-300S-BK	GT-300S-UV	300	11 1/2"	4.6	80	50 (22)		12,000PCS.
GT-370S	GT-370S-BK	GT-370S-UV	370	14 1/2"	4.6	102	50 (22)		12,000PCS.
GT-385S	GT-385S-BK	GT-385S-UV	385	15 3/16"	4.6	105	50 (22)		12,000PCS.
GT-430S	GT-430S-BK	GT-430S-UV	430	17"	4.6	120	50 (22)		12,000PCS.
GT-120ST	GT-120ST-BK	GT-120ST-UV	120	4 3/4"	4.8	27	50 (22)		20,000PCS.
GT-160ST	GT-160ST-BK	GT-160ST-UV	160	6 1/4"	4.8	39	50 (22)		15,000PCS.
GT-190ST	GT-190ST-BK	GT-190ST-UV	190	7 1/2"	4.8	49	50 (22)		13,000PCS.
GT-250ST	GT-250ST-BK	GT-250ST-UV	250	10"	4.8	68	50 (22)		12,000PCS.
GT-280ST	GT-280ST-BK	GT-280ST-UV	280	11"	4.8	77	50 (22)		10,000PCS.
GT-300ST	GT-300ST-BK	GT-300ST-UV	300	11 5/8"	4.8	83	50 (22)		10,000PCS.
GT-310ST	GT-310ST-BK	GT-310ST-UV	310	12"	4.8	86	50 (22)		10,000PCS.
GT-370ST	GT-370ST-BK	GT-370ST-UV	368	14 1/2"	4.8	105	50 (22)		9,000PCS.
GT-390ST	GT-390ST-BK	GT-390ST-UV	385	15 3/16"	4.8	110	50 (22)		9,000PCS.
GT-430ST	GT-430ST-BK	GT-430ST-UV	432	17"	4.8	125	50 (22)		8,500PCS.
GT-450ST	GT-450ST-BK	GT-450ST-UV	450	17 3/4"	4.8	131	50 (22)		8,000PCS.
GT-500ST	GT-500ST-BK	GT-500ST-UV	500	19 11/16"	4.8	147	50 (22)		6,000PCS.
GT-550ST	GT-550ST-BK	GT-550ST-UV	550	21 11/16"	4.8	162	50 (22)		5,000PCS.
GT-610ST	GT-610ST-BK	GT-610ST-UV	610	24"	4.8	181	50 (22)	5,000PCS.	
GT-635ST	GT-635ST-BK	GT-635ST-UV	635	25"	4.8	189	50 (22)	5,000PCS.	
GT-920ST	GT-920ST-BK	GT-920ST-UV	914	36"	4.8	278	50 (22)	3,500PCS.	

CABLE TIE

ITEM NO.			L		W	MAX.BUNDLE	MIN.TENSILE STRENGTH		PACKING PER CARTON
NATURAL	BLACK	UV	mm	inch	mm	mm	lbs(kgs)	CLASS	
GT-370H	GT-370H-BK	GT-370H-UV	370	14 1/2"	7.6	102	120 (55)	HEAVY DUTY	4,500PCS.
GT-450H	GT-450H-BK	GT-450H-UV	450	17 3/4"	7.6	128	120 (55)		3,500PCS.
GT-500H	GT-500H-BK	GT-500H-UV	500	19 11/16"	7.6	143	120 (55)		1,600PCS.
GT-550H	GT-550H-BK	GT-500H-UV	550	21 11/16"	7.6	160	120 (55)		1,200PCS.
GT-150HD	GT-150HD-BK	GT-150HD-UV	150	6"	7.6	32	120 (55)		7,500PCS.
GT-200HD	GT-200HD-BK	GT-200HD-UV	203	8"	7.6	52	120 (55)		6,500PCS.
GT-250HD	GT-250HD-BK	GT-250HD-UV	240	9 7/16"	7.6	61	120 (55)		6,000PCS.
GT-280HD	GT-280HD-BK	GT-280HD-UV	280	11"	7.6	74	120 (55)		5,000PCS.
GT-300HD	GT-300HD-BK	GT-300HD-UV	300	11 7/8"	7.6	80	120 (55)		5,000PCS.
GT-340HD	GT-340HD-BK	GT-340HD-UV	340	13 1/2"	7.6	92	120 (55)		5,000PCS.
GT-370HD	GT-370HD-BK	GT-370HD-UV	380	15"	7.6	108	120 (55)		4,500PCS.
GT-750HD	GT-750HD-BK	GT-750HD-UV	750	29 2/1"	7.6	223	157 (80)		1,000PCS.
GT-430HD	GT-430HD-BK	GT-430HD-UV	450	17 3/4"	8.0	128	175 (80)		HEAVY DUTY
GT-500HD	GT-500HD-BK	GT-500HD-UV	500	19 11/16"	8.0	143	175 (80)	1,600PCS.	
GT-530HD	GT-530HD-BK	GT-530HD-UV	550	21 11/16"	8.0	160	175 (80)	2,500PCS.	
GT-450HD	GT-450HD-BK	GT-450HD-UV	450	17 3/4"	9.0	128	175 (80)	3,500PCS.	
GT-550HD	GT-550HD-BK	GT-550HD-UV	550	21 3/5"	9.0	155	175 (80)	2,500PCS.	
GT-610HD	GT-610HD-BK	GT-610HD-UV	605	24"	9.0	177	175 (80)	2,000PCS.	
GT-685HD	GT-685HD-BK	GT-685HD-UV	680	27"	9.0	202	175 (80)	2,000PCS.	
GT-710HD	GT-710HD-BK	GT-710HD-UV	705	28"	9.0	209	175 (80)	1,800PCS.	
GT-760HD	GT-760HD-BK	GT-760HD-UV	762	30"	9.0	227	175 (80)	1,000PCS.	
GT-780HD	GT-780HD-BK	GT-780HD-UV	780	30 2/1"	9.0	228	175 (80)	1,000PCS.	
GT-830HD	GT-830HD-BK	GT-830HD-UV	812	32"	9.0	243	175 (80)	1,000PCS.	
GT-920HD	GT-920HD-BK	GT-920HD-UV	914	36"	9.0	275	175 (80)	1,500PCS.	
GT-940HD	GT-940HD-BK	GT-940HD-UV	950	37"	9.0	284	175 (80)	1,000PCS.	
GT-1170HD	GT-1170HD-BK	GT-1170HD-UV	1168	46"	9.0	356	175 (80)	1,100PCS.	
GT-1220HD	GT-1220HD-BK	GT-1220HD-UV	1219	48"	9.0	372	175 (80)	1,000PCS.	
GT-1500HD	GT-1500HD-BK	GT-1500HD-UV	1500	59"	9.0	462	175 (80)	1,000PCS.	
GT-280EHD	GT-280EHD-BK		280	11"	12.7	73	250 (114)	EXTRA HEAVY DUTY	3,000PCS.
GT-380EHD	GT-380EHD-BK		380	15"	12.7	105	250 (114)		2,200PCS.
GT-480EHD	GT-480EHD-BK		480	18 7/8"	12.7	137	250 (114)		2,000PCS.
GT-550EHD	GT-550EHD-BK		550	21 11/16"	12.7	159	250 (114)		1,600PCS.
GT-580EHD	GT-580EHD-BK		580	22 7/8"	12.7	160	250 (114)		1,500PCS.
GT-730EHD	GT-730EHD-BK		730	28 3/4"	12.7	216	250 (114)		1,200PCS.
GT-880EHD	GT-880EHD-BK		880	34 11/16"	12.7	264	250 (114)		1,000PCS.
GT-1030EHD	GT-1030EHD-BK		1030	40 1/2"	12.7	312	250 (114)		800PCS.

Nylon Cable Tie, Wiring Accessories

Quick Fitting, Terminal, Copper Tube Terminal

Crimping Tool, Hydraulic Tool

MARKER TIE



- Material: UL approved NYLON 66, 94V-2.
- Tie and identify bundles of cable in one operation. Flat areas may be imprinted or written on with Marker Pen.

Unit:mm

ITEM NO.	Length	Width	Max. Bundle Dia	Min. Tensile Strength		Marking Pad Size A x B	PACKING.	
				lbs	kgs		pcs / bag	pcs / carton
MCV-100	100	2.5	23	18	8	8 x 25	100PCS	25,000PCS.
MCV-100L	130	2.5	22	18	8	28 x 20		20,000PCS.
MCV-110	110	2.5	20	18	8	8 x 25		25,000PCS.
MCV-200	200	4.6	50	50	22	28 x 13		12,000PCS.
MCV-200S	200	2.5	50	18	8	15 x 30		12,000PCS.
MCV-270	270	4.6	75	50	22	28 x 13		12,000PCS.
MCV-300	300	4.8	82	50	22	54.5 x 13		8,000PCS.
MCV-370	370	4.8	105	50	22	54.5 x 13		7,000PCS.



Nylon Cable Tie, Wiring Accessories

MOUNTING TIE

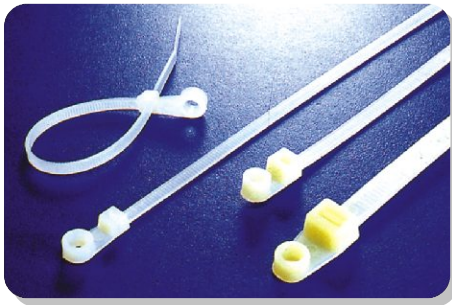

- Material: UL approved NYLON 66, 94V-2.
- Color: Natural.(color black upon request).
- These cable ties can be secured to panel with a single bolt.

Unit:mm

ITEM NO.	Length (L)	Width (W)	A	Max. Bundle Dia.	Min. Tensile Strength		PACKING.	
					lbs	kgs	Pcs / bag	pcs / carton
TCV-100	113	2.5	3.2	25	18	8	100PCS	32,000PCS.
TCV-155	171.5	3.7	3.7	40	40	18		18,000PCS.
TCVS-170	171	3.7	3.7	40	40	18		17,000PCS.
TCV-205	221.3	4.2	4.2	52	50	22		12,000PCS.
TCV-300	300	4.8	4.8	85	50	22		10,000PCS.
TCV-300L	317.2	7.8	7.8	80	120	55		5,000PCS.
TCV-370	370	4.8	4.8	102	50	22		7,500PCS.
TCV-400	410	7.8	7.8	112	120	55		3,200PCS.

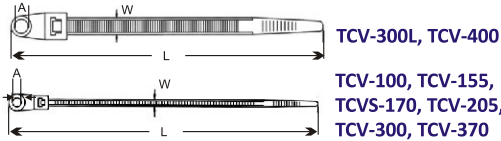

Quick Fitting, Terminal, Copper Tube Terminal

RELEASABLE CABLE TIE



- Material: UL approved Black NYLON 66, 94V-2
- Color: Natural, Black
- These cable ties are easily assembled by hand or by pliers. Remain securely locked until intentionally released by operating the finger catch.

Unit:mm

ITEM NO.		Length L	Width W	Max. Bundle Dia.	Min. Tensile Strength		PACKING.
NATURAL	BLACK				lbs	kgs	
HV-125	HV-125-BK	125	7.6	30	50	22	100PCS
HV-150	HV-150-BK	150	7.6	35	50	22	
HV-200	HV-200-BK	203	7.6	50	50	22	
HV-250	HV-250-BK	250	7.6	65	50	22	
HV-300	HV-300-BK	300	7.6	80	50	22	

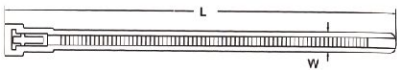

- Material: UL approved NYLON 66, 94V-2.
- Finger catch designs to release cable tie locking where replacement is required. Good for temporary fastening purpose.

Unit:mm

ITEM NO.	Length L	Width W	Max. Bundle Dia.	Min. Tensile Strength		PACKING.
				lbs	kgs	
RCV-100	102	3.6	25	40	18	100PCS
RCV-150	150	4.6	39	50	22	
RCV-200	200	4.6	55	50	22	
RCV-250	250	4.8	74	50	22	
RCV-300	300	4.8	88	50	22	
RCV-370	370	4.8	102	50	22	
RCV-230XL	232.5	12.8	60	250	114	
RCV-290XL	292.5	12.8	79	250	114	
RCV-405XL	407.5	12.8	116	250	114	
RCV-480XL	482.5	12.8	140	250	114	
RCV-580XL	576.6	12.8	172	250	114	

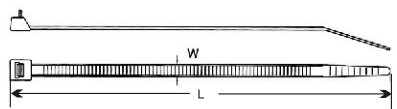
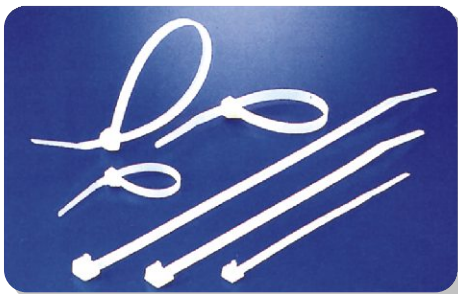

Crimping Tool, Hydraulic Tool

SECURITY TIE

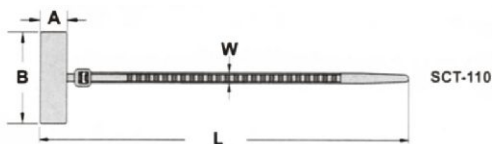
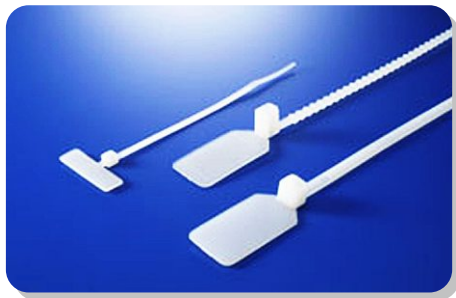

- Material: UL approved Nylon 66, 94V-2
- Feature: for the purpose of identification for security service logistics, transportation and courier. The size of marker plate could be made or carved LOGO upon customer's request.

Unit:mm

ITEM NO.	L	W	Max. Bundle Dia	Marking pad A x B	Tensile Strength		PACKING.
					lbs	kgs	
SCT-110	111	2.6	20	8 x 27.6	11	5	100pcs
SCT-250	248.5	3.5	50	36 x 19	22	10	
SCT-400	400	4.8	102	36.5 x 19	55	25	



PUSH MOUNT COLLECT TIE

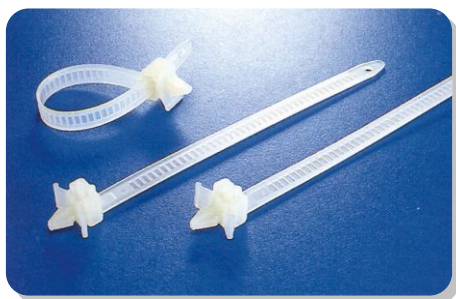

- Material: UL approved NYLON 66, 94V-2.

Unit:mm

ITEM NO.	L		W	Max. Bundle Dia	Tensile Strength		PACKING.
	mm	inch			lbs	kgs	
PHV-150	152.5	6"	7.9	37	30	13	100pcs/BAG

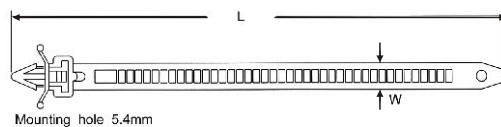
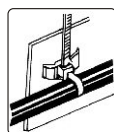

PUSH MOUNT TIE

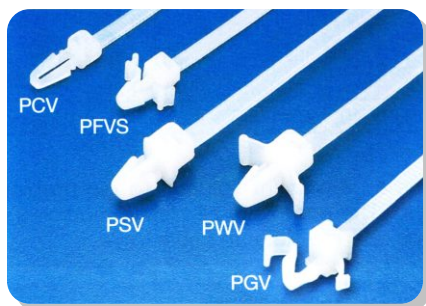

- Material: UL approved NYLON 66, 94V-2.
 - ※ PGV-100V0, PGV-130V0: UL approved NYLON 66, 94V-0
 - ※ PRVS-130HSBK: UL approved heat stabilized NYLON 66, 94V-2
- Press the tie into a pre-drilled hole simple and secure one-piece harness tying and mounting.

Unit:mm

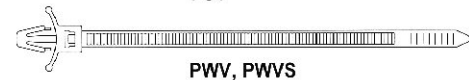
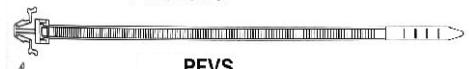
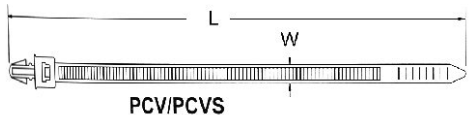
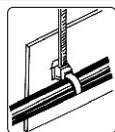

ITEM NO.	L	W	Max. Bundle Dia	Tensile Strength		mounting hole	Chassis	PACKING.
				lbs	kgs			
PCVS-130	132	4.8	30	50	22	4.8	3.0	100pcs
PCV-155	168	3.8	40	40	18	4.8	3.0	
PCVS-200	203	4.8	50	50	22	4.8	3.0	
PCV-200	203	4.8	50	50	22	6.4	3.0	
PFVS-130	131	3.7	30	40	18	4.8	2.4	
PFVS-155	157.5	3.7	38	40	18	4.8	2.4	
PFVS-200	207	3.7	50	40	18	4.8	2.4	
PGV-100	101	3.4	25	40	18	4.8	2.5	
PGV-130	135	3.4	33	40	18	4.8	2.5	
PSV-130	132	4.8	30	50	22	6.4	3.3	
PSV-200	202	4.8	50	50	22	6.4	3.3	
PWVS-100	112	2.5	25	18	8	4.6	2.6	
PWVS-130	133	4.8	30	50	22	4.6	4.5	
PWVS-155	157	3.5	36	40	18	4.6	3.0	
PWV-130	132	4.8	30	50	22	6.0	2.8	
PWV-170	170	4.6	40	50	22	6.0	3.0	
PWV-200	201	4.8	50	50	22	6.0	2.8	
PRVS-130HSBK	134.5	4.8	30	50	22	4.8	5.3	

STAINLESS STEEL CABLE TIE

Unit:mm



- Material: Stainless Steel 304SS or 316SS
- Feature: To be quickly & easily installed. Designed for high-temperature application in severe environmental conditions.

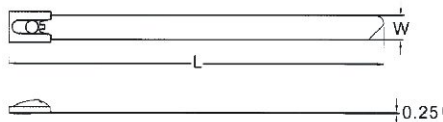

ITEM NO.		L		W	lbs	MAX. BUNDLE DIA.	PACKING
304SS	316SS	mm	inch				
BCT-127ST	BST-127ST	127	5"	4.6	100	25	100pcs
BCT-152ST	BST-152ST	152	6"	4.6	100	33	
BCT-201ST	BST-201ST	201	8"	4.6	100	51	
BCT-266ST	BST-266ST	266	10 1/2"	4.6	100	69	
BCT-300ST	BST-300ST	300	11 7/8"	4.6	100	80	
BCT-362ST	BST-362ST	362	14 1/4"	4.6	100	102	
BCT-400ST	BST-400ST	400	15 4/3"	4.6	100	115	
BCT-521ST	BST-521ST	521	20 1/2"	4.6	100	152	
BCT-679ST	BST-679ST	679	26 3/4"	4.6	100	203	
BCT-838ST	BST-838ST	838	33"	4.6	100	254	50pcs
BCT-1067ST	BST-1067ST	1067	42"	4.6	100	346	
BCT-1194ST	BST-1194ST	1194	47"	4.6	100	360	
BCT-127HD	BST-127HD	127	5"	7.9	250	25	100pcs
BCT-152HD	BST-152HD	152	6"	7.9	250	33	
BCT-201HD	BST-201HD	201	8"	7.9	250	51	
BCT-266HD	BST-266HD	266	10 1/2"	7.9	250	69	
BCT-300HD	BST-300HD	300	11 7/8"	7.9	250	80	
BCT-362HD	BST-362HD	362	14 1/4"	7.9	250	102	
BCT-521HD	BST-521HD	521	20 1/2"	7.9	250	152	
BCT-679HD	BST-679HD	697	26 3/4"	7.9	250	203	
BCT-838HD	BST-838HD	838	33"	7.9	250	254	
BCT-1067HD	BST-1067HD	1067	42"	7.9	250	346	
BCT-1194HD	BST-1194HD	1194	47"	7.9	250	360	

Nylon Cable Tie, Wiring Accessories

Quick Fitting Terminal, Copper Tube Terminal

STAINLESS STEEL CABLE TIE WITH COATING

Unit:mm



- Material: Stainless Steel 316SS with Epoxy coating.
- Feature: Quick to fasten. Resistance on corrosion, bad weather, and flame .
- Suitable for engineering, aviation, ship and indoor or outdoor environments of high-humidity, high-temperature, and coldness.

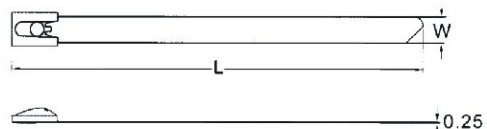

ITEM NO.		L		W	lbs	MAX. BUNDLE DIA.	PACKING
316SS		mm	inch				
BSTC-127ST		127	5"	4.6	100	25	100pcs
BSTC-152ST		152	6"	4.6	100	33	
BSTC-201ST		201	8"	4.6	100	51	
BSTC-266ST		266	10 1/2"	4.6	100	69	
BSTC-300ST		300	11 7/8"	4.6	100	80	
BSTC-362ST		362	14 1/4"	4.6	100	102	
BSTC-400ST		400	15 4/3"	4.6	100	115	
BSTC-521ST		521	20 1/2"	4.6	100	152	
BSTC-679ST		679	26 3/4"	4.6	100	203	
BSTC-838ST		838	33"	4.6	100	254	50pcs
BSTC-1067ST		1067	42"	4.6	100	346	
BSTC-1194ST		1194	47"	4.6	100	360	
BSTC-127HD		127	5"	7.9	250	25	100pcs
BSTC-152HD		152	6"	7.9	250	33	
BSTC-201HD		201	8"	7.9	250	51	
BSTC-266HD		266	10 1/2"	7.9	250	69	
BSTC-300HD		300	11 7/8"	7.9	250	80	
BSTC-362HD		362	14 1/4"	7.9	250	102	
BSTC-521HD		521	20 1/2"	7.9	250	152	
BSTC-679HD		697	26 3/4"	7.9	250	203	
BSTC-838HD		838	33"	7.9	250	254	
BSTC-1067HD		1067	42"	7.9	250	346	
BSTC-1194HD		1194	47"	7.9	250	360	

Crimping Tool, Hydraulic Tool

TIE MOUNT (SELF-ADHESIVE)

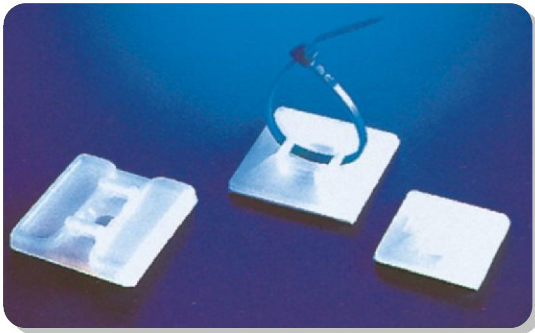

- Material: UL approved NYLON 66, 94V-2 (backed with adhesive tape.)
- Color: Natural, available in color black.
- SELF-ADHESIVE TIE MOUNTS Is designed to support low weight wire bundles when properly applied on any clean, smooth, grease-free surface. For heavy support. Mounting hole is provided for screws.
- To apply, simply peel off backing paper and apply mount to surface. After that, cable ties can be inserted to secure wire bundles.
- To apply with ELECMIT Nylon Cable Ties.

Unit:mm

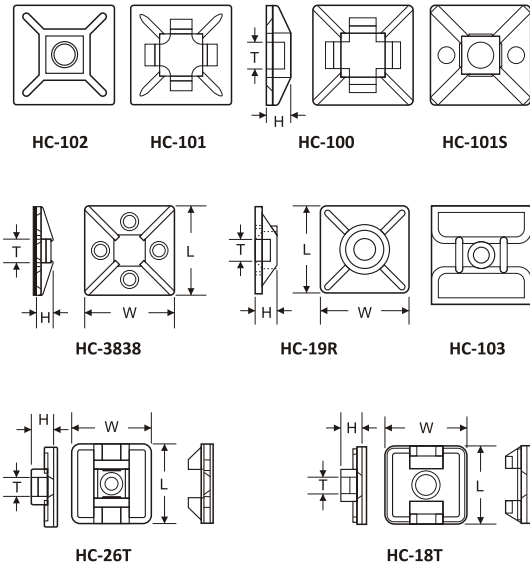

※
※

ITEM NO.	L	W	H	MOUNTING HOLE	T	PACKING.
HC-100-S4	12.5	12.5	3.2	-	3.2	100pcs
HC-101S-S2	19.5	19.5	3.9	3.2	4.6	
HC-101S	19.5	19.5	3.9	3.2	4.6	
HC-101	21.8	21.8	4.0	-	4.8	
HC-102	28.6	28.6	5.3	5.0	5.5	
HC-103	29.2	29.2	5.4	5.0	5.5	
HC-25	26.1	26.1	6.0	4.3	8.0	
HC-19R	18.9	18.9	4.6	4.8	4.2	
HC-26R	26.3	26.3	6.0	5.0	5.6	
HC-18T	19.0	19.0	5.0	4.4	4.1	
HC-26T	26.5	26.5	7.4	4.3	5.8	
HC-3838	38.5	38.5	7.6	5.0	10.2	

※HC-100-S4 4pcs on a strip. ※HC-101S-S2 2pcs on a strip.

SADDLE TYPE TIE MOUNT

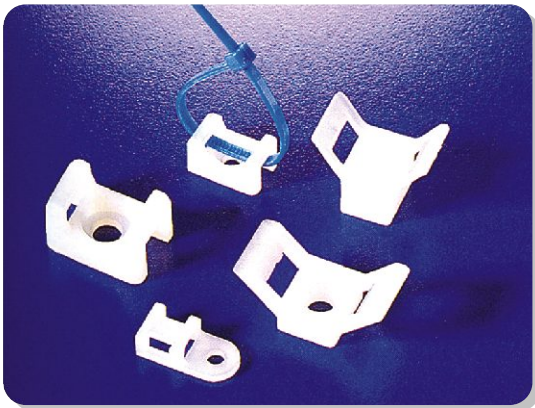

- Material: UL approved NYLON 66, 94V-2
- Color: Natural, available in color black.
- To apply with ELECMIT Nylon Cable Ties:
 HC-0: GT-80M, GT-100M.....GT-280ST, GT-310ST
 HC-1: GT-80M, GT-100M.....GT-280ST, GT-310ST
 HC-2: For all of ELECMIT Nylon Cable Ties.
- Saddle design provides maximum stability to wire bundles.
- To apply, simply fix mount with a screw and secure wire bundles with ELECMIT Nylon Cable Ties.

Unit:mm

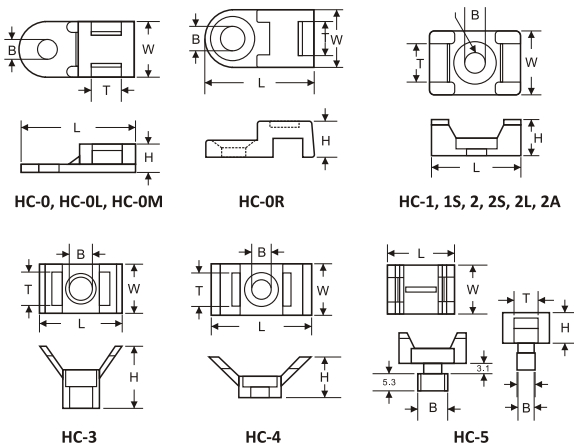

ITEM NO.	H	L	W	T	B	PACKING.
HC-0	5.0	19.6	9.5	5.2	3.7	100pcs
HC-0M	5.0	19.0	9.5	5.0	4.3	
HC-0L	5.0	19.0	9.5	5.0	5.2	
HC-0R	6.2	19.1	10.0	5.4	4.2	
HC-1	7.0	15.0	10.0	5.1	3.5	
HC-1S	5.8	12.8	7.0	4.0	3.3	
HC-2S	9.8	23.0	16.0	9.0	5.0	
HC-2	9.8	23.0	16.0	9.0	6.3	
HC-2A	10.4	20.5	17.1	10.4	5.0	
HC-2L	9.8	23.0	16.0	9.0	6.5	
HC-3	17.5	23.0	13.8	9.5	5.3	
HC-4	11.6	30.0	14.7	9.3	5.0	
HC-5	10.0	21.5	16.0	7.8	5.8x9.7	

SPIRAL WRAPPING BAND

Nylon Cable Tie, Wiring Accessories



An economical way of cable binding. Easily applied to electric harness, cables and wire bundles. Cut-to-fit versatility in convenient roll-form.

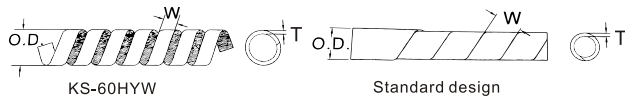

- Material : P.E.
- Color : Standard in natural. Black color upon request.

Description :

- Flexible construction enable bands to follow wire ways easily.
- Durable, reusable with retained spiral strength.
- Fix ends of band with ELECMIT Cable Ties and spiral wire bundles in clockwise direction to complete works.
- Expand spiral range almost without limit.

Unit:mm

ITEM NO.	O.D.	T	W	Wrapping range (mmø)	PACKING
KS-3	3.0	0.5	4.7	1.5~10	700ROLL
KS-6	4.5	0.6	6.7	2.5~15	420ROLL
KS-6L	6.0	0.6	7.4	4~25	300ROLL
KS-6.5	6.5	0.55	7.9	5~25	250ROLL
KS-8	8.0	0.75	12.0	6~30	180ROLL
KS-10	10.0	0.8	12.3	7.5~30	125ROLL
KS-12	12.0	0.85	15.0	9~32	90ROLL
KS-15	15.0	1.0	15.5	12~35	60ROLL
KS-19	19.0	1.2	19.2	15~50	40ROLL
KS-24	24.0	1.3	21.5	20~100	25ROLL
KS-30HYW	34.0	2.5	38.0	26~130	30ROLL
KS-60HYW	60.0	2.5	27.0	=	15ROLL

10M/ROLL

2M/ROLL

Quick Fitting, Terminal, Copper Tube Terminal

Crimping Tool, Hydraulic Tool

WRAPPING BAND



- Material:PVC Flamability rating.
- Application:
 1. Good for cable wrapping.
 2. Easy to wrap, reusable.



Cut-to-Fit Versatility in Convenient roll-form

BUTTON TYPE

Unit:mm

ITEM NO.		BUTTON DISTANCE	MAX. BUNDLE DIA.	PACKING
GRAY	BLACK/GRAY			
WB-40	WBS-40	40	12	60 YARDS/RL (55 METERS)
WB-47	WBS-47	47	15	
WB-60	WBS-60	60	20	
WB-80	WBS-80	80	25	
WB-100	WBS-100	100	30	
WB-128	WBS-128	128	40	
WB-140	WBS-140	140	44	
WB-150	WBS-150	150	47	
WB-160	WBS-160	160	50	
WB-182	WBS-182	182	57	
WB-222	WBS-222	222	70	
WB-315	WBS-315	315	100	
WB-475	WBS-475	475	150	

TAPE TYPE

ITEM NO.	BAND WIDTH (mm)	MAX. BUNDLE DIA.(mm)	PACKING
WBT-84	84	20	60 YARDS/RL (55 METERS)
WBT-100	100	25	
WBT-115	115	30	
WBT-147	147	40	
WBT-183	183	50	
WBT-246	246	70	
WBT-340	340	100	

SPLIT WRAPPING BAND

Unit:mm

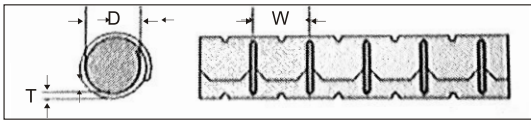

ITEM NO.	D	T	W	Wrapping range (mmØ)	PACKING
KL-8BK	8.0	0.8	9.0	10.0	5M/BAG other length upon request
KL-15BK	15.0	0.8	13.0	16.0	
KL-20BK	20.0	0.9	15.0	22.0	
KL-25BK	25.0	1.3	18.0	27.0	
KL-32BK	32.0	1.3	23.0	35.0	

- Material: PP BLACK. (Gray color upon request)
- Instruction: Cut the length you need and wrap all the cables with special installation tool.
- Feature:
 - It's difficult to deform during the usement,can be reused many time and still maintain spiral strength.
 - Protect cables from cuts and damage.

SPLIT WRAPPING BAND INSTALLATION TOOL

Unit:mm

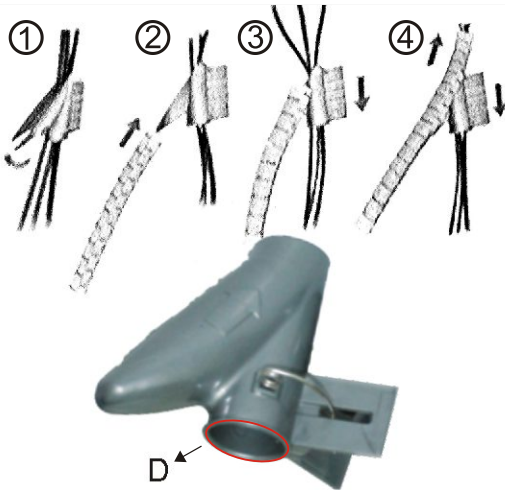

ITEM NO.	D	PACKING	Suitable for
KT-8BK	8.0	10pcs	KL-8BK
KT-15BK	15.0		KL-15BK
KT-20BK	22.0		KL-20BK
KT-25BK	25.0		KL-25BK
KT-32BK	32.0		KL-32BK

- Material: PP BLACK(Gray color upon request)
- Using process: First, put all the cables in the tool and hold the top of wrapping band and insert the peak of the tool. Then, push downwards through wrapping band and all the cables can be tidy up immediately.

O TYPE MARKER TUBE

Unit:mm

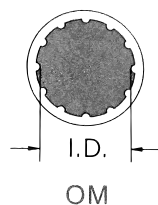

ITEM NO.	Suitable Wire		Wire Dia I.D.	PACKING
	AWG	sq		
OMR-0.75	18	0.75	3.0	500M/ROLL
OMR-1.25	16	1.25	3.2	550M/ROLL
OMR-2.0	14	2.0	3.6	500M/ROLL
OMR-3.5	12	3.5	4.2	400M/ROLL
OMR-5.5	10	5.5	5.1	200M/ROLL
OMR-8	8	8.0	6.2	50M/ROLL

- Material: Soft durable PVC (white), resist oil, grease and other material erosion.
- Feature: Air filled with rifting design inside the tube maintain it's shape and not twist. Suitable for typing machine.
- Special length upon request.

CABLE MARKER

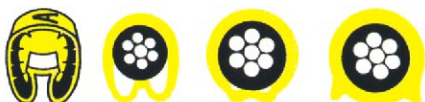

EC TYPE CABLE MARKER

- **MATERIAL:** Made of finest soft grade, strong, durable P.V.C. ,which resists oil, grease, acid, abrasion and chemicals.
- Maximum service temperature:85°C.
- Marker tongue spans to fit various cable diameters and retracts to hold wires firmly in position.
- **Description:** ELECMIT Cable Marker features high quality flexible interior to fit various cable diameters.
- The markers stay attached on a roller and can be despatched easily when needed.
- Bold print on yellow body to show your codes distinctly. Any numbers can be composed by arranging letters and numbers in sequence to provide the necessary codes.
- To be fitted before the terminal is attached or solder connection made and grip cables firmly in position.

Unit:mm

SHAPE	ITEM NO.	DIA RANGE MIN.-MAX.	SUITABLE WIRE	STANDARD MARKINGS	PACKING PER ROLL	STANDARD COLOR	COLORFUL CABLE MARKER
PLAIN CUT 	EC-0	2.0-3.2	0.12~0.75mm ²	Solid number or letter roll for 0,1,2,3,.....9 A,B,.....Z +,-, = (earth) Blank, / (Slant)	1000pcs	Yellow body with black printed.	0:Black 1:Brown 2:Red 3:Orange 4:Yellow 5:Green 6:Blue 7:Violet 8:Gray 9:White
	EC-1	3.0-4.2	0.75-3.5mm ²		1000pcs		
	EC-2	3.6-7.4	3.5-8.0mm ²		500pcs	White body upon request.	
	EC-3	6.2-10.0	8-22mm ²		250pcs		

Nylon Cable Tie, Wiring Accessories

Quick Fitting Terminal, Copper Tube Terminal

FLAT CABLE MARKER



Unit:mm

ITEM NO.	CABLE DIA		MARKER LENGH	STANDARD MARKINGS	PACKING PER ROLL
	sq	mm			
FM-1	2~8	3.5~7.0	5	0,1,2,3,.....9 A,B,.....Z +,-, =, /, Blank	500pcs



- Unique oval shape design provided.
 - 1.slip over cable directly (for small cable)
 - 2.slip onto marker strip (for larger cable or cable bundles)

Crimping Tool, Hydraulic Tool

MARKER STRIP



- Material: UL approved Nylon 66 (black) , flammability rating 94V-2.
- NYLON 66 PLATE with cable tie fastening hole to accommodate marker pieces for easy identification of cable runs.

Unit:mm

ITEM NO.	L	W	T	AVAILABLE LOADED QUANTITY OF FM-1 CABLE MARKER	PACKING
MS-65	65	9	6.7	9pcs	100pcs
MS-100	100	9	6.95	16pcs	
MS-135	135	9	7	23pcs	
MS-135L	135	9	13	21pcs	

CLIP-ON CABLE MARKER

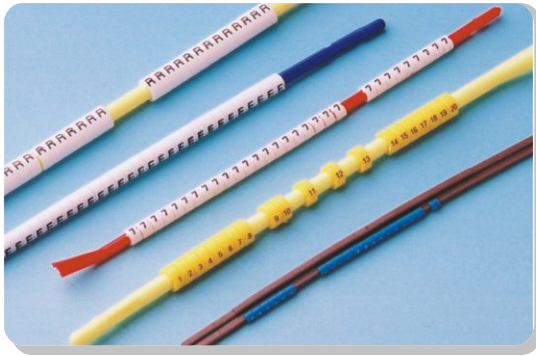

- Black legends on white background.
- Install before or after termination is made.
- Withstanding harsh environment and high temperature. from -22°F(-30°C) to 194°F(90°C).
- Removable and reusable.
- Resistant to chemical environments.
- 30 pcs/Rod for Solid number 0,1,2,3,.....9 & for letter A,B,C,.....Z,+,-,=,Blank.
- Material: ACETAL

Unit:mm

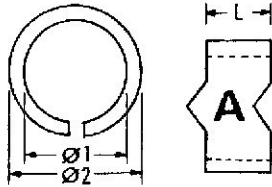

ITEM NO.	Wire range	MOUNTING HOLE(mm)		
		L	Ø1	Ø2
LT-020	AWG 26-30	2.3	0.95	1.9
LT-021	AWG 24-22	3.0	1.5	2.8
LT-022	AWG 22-20	3.0	2.0	3.4
LT-023	AWG 18-16	3.0	2.5	4.0
LT-024	AWG 16-14	3.0	3.2	4.6
LT-025	AWG 14-12	3.0	3.7	5.2
LT-026	AWG 12-10	3.0	4.2	6.0

VINYL WIRE TUBE END CAP



- Material: Soft P.V.C.
- Maximum service temperature: 80°C.
- For the insulation works of wire end terminal. Performing the work with a simple one-touch to tighten and seal which can avoid dirt, moisture and water.
- Standard color: Red, White, Blue, Yellow, Black(Green, Brown available upon special request)

Unit:mm

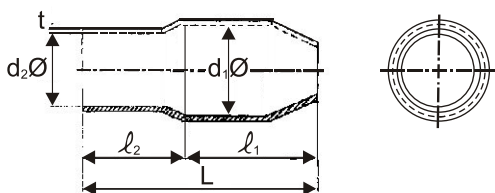
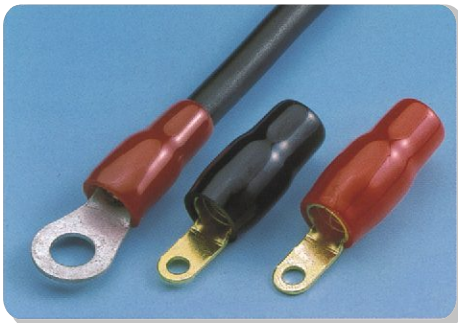

ITEM NO.	Applicable wires	d ₂ Ø	d ₁ Ø	l ₁ ±1	l ₂ ±1	L±2	±0.2	PACKING UNIT
V-1.25	1.25mm ²	3.3	3.1	7.0	8.0	15.0	0.6	100pcs
V-2	2.0mm ²	4.5	3.7	8.0	8.0	16.0	0.7	
V-3.5	3.5mm ²	5.7	4.1	9.0	9.0	18.0	0.8	
V-5.5	5.5mm ²	5.7	5.2	10.0	10.0	20.0	0.8	
V-8	8.0mm ²	7.2	6.2	11.0	10.0	21.0	1.0	
V-12	12mm ²	10.0	7.3	13.0	14.0	27.0	1.1	
V-14	14mm ²	10.0	8.0	15.0	13.0	28.0	1.1	
V-22	22mm ²	12.0	9.5	15.0	14.0	29.0	1.2	
V-38	38mm ²	14.0	11.8	17.0	17.0	34.0	1.4	
V-60	60mm ²	17.0	13.9	22.0	20.0	42.0	1.5	
V-70	70mm ²	17.9	15.1	25.5	19.0	45.0	1.5	50pcs
V-80	80mm ²	19.5	16.0	25.0	21.0	46.0	1.5	
V-100	100mm ²	22.0	18.0	31.0	24.0	55.0	1.7	
V-125	125mm ²	24.4	20.0	32.0	28.0	60.0	1.8	
V-150	150mm ²	26.0	22.0	34.0	31.0	65.0	1.8	
V-185	185mm ²	29.0	24.0	33.0	33.4	66.7	1.8	25pcs
V-200	200mm ²	32.2	24.0	38.0	31.0	69.0	2.0	
V-250	250mm ²	37.5	26.5	42.0	33.0	75.0	2.0	
V-325	325mm ²	37.5	30.0	42.0	33.0	75.0	2.0	
V-400	400mm ²	45.1	37.5	43.0	40.0	83.0	2.0	
V-500	500mm ²	48.2	40.2	43.0	42.0	85.0	2.0	25pcs
V-630	630mm ²	53.8	45.2	48.0	45.0	93.0	2.0	

NAIL CABLE CLIP

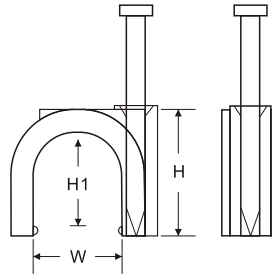
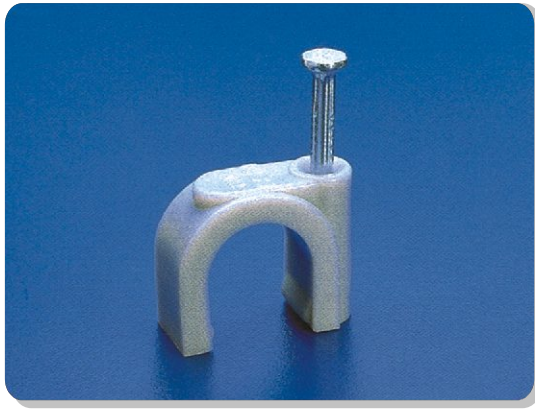

- Material: High Impact PE
- Color: Gray (others available upon request).
- Applied for general round cables.
- With steel nail inserted, steel nail for masonry

Unit:mm

ITEM NO.	W	H	H1	NAILS	PACKING
NC-0.5NS	5.0	7.6	5.0	2.0 x 20	100pcs
NC-1NS	6.0	9.0	6.6	2.0 x 20	
NC-2NS	8.0	12.9	8.15	2.0 x 25	
NC-2.5NS	9.0	12.0	9.0	2.0 x 25	
NC-3NS	10.0	12.8	10.4	2.0 x 25	
NC-0.275N	2.75	4.5	2.6	1.65 x 19	100pcs
NC-0.35N	3.5	5.9	3.7	2.0 x 15	
NC-0.4N	4.0	6.6	4.2	2.5 x 18	
NC-0.5N	5.0	7.6	5.0	2.5 x 18	
NC-0.5NBK	5.0	7.6	5.0	2.5 x 18	
NC-1N	6.0	9.6	6.6	2.5 x 18	
NC-1NBK	6.0	9.6	6.6	2.5 x 18	
NC-1NL	6.0	10.5	6.9	2.5 x 20	
NC-1.5N	7.0	11.0	7.5	2.5 x 22	
NC-1.5NBK	7.0	11.0	7.5	2.5 x 22	
NC-2N	8.0	12.9	8.2	2.5 x 22	
NC-2.5N	9.0	12.8	9.0	2.5 x 22	
NC-3N	10.0	13.8	10.4	2.5 x 25	
NC-3.5N	11.0	16.6	12.2	2.5 x 27	
NC-4N	12.0	16.0	12.3	2.5 x 27	
NC-6N	14.0	20.0	15.6	3.0 x 35	
NC-7N	16.0	21.7	17.0	3.2 x 38	
NC-7.2N	18.0	22.4	17.5	3.2 x 38	
NC-7.5N	20.0	23.5	18.5	3.2 x 38	
NC-8N	22.0	27.8	23.0	3.2 x 42	
NC-9NS	23.0	29.0	24.1	3.2 x 47	
NC-9N	25.0	30.4	26.0	3.2 x 47	
NC-10N	32.0	40.0	33.5	3.6 x 56	50pcs

Nylon Cable Tie, Wiring Accessories

Quick Fitting, Terminal, Copper Tube Terminal

Crimping Tool, Hydraulic Tool

DOUBLE NAIL CABLE CLIP

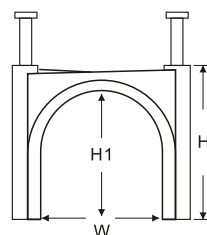

- Material: High impact PE.
- Color: Gray (others available upon request).
- Feature: Double nails ensure cable firmly in place.
- With steel nails inserted, steel nails for masonry

Unit:mm

ITEM NO.	W	H	H1	SUITABLE WIRES	NAILS	PACKING
DNC-06	17	21.5	17.7	3/8" PVC PIPE	2.0 x 44	50pcs
DNC-10	32	40	33.5	1" PVC PIPE	3.6 x 56	20pcs
DNC-12	40	50	41	1 1/4" PVC PIPE	4.0 x 68	
DNC-15	50.3	48.3	50.3	1 1/2" PVC PIPE	4.0 x 78	
DNC-20	62	71	62	2" PVC PIPE	4.0 x 97	

NAIL FLAT CABLE CLIP

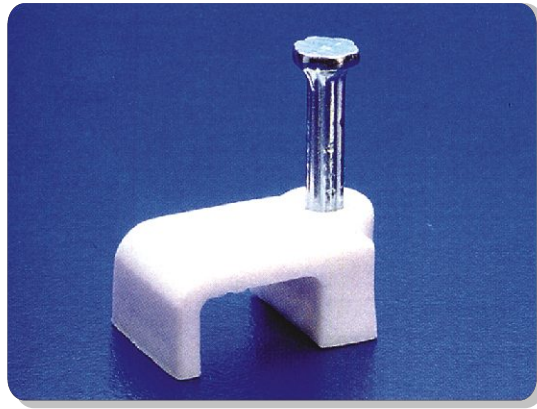

- Material: High impact PE (White).
- Applied for phone cords.
- With steel nail inserted, steel nail for masonry.
- Color: White (others available upon request).

Unit:mm

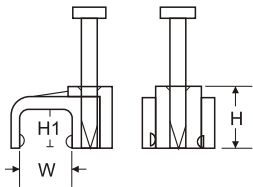

Standard design

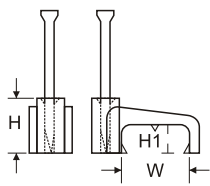

NF-2.6S

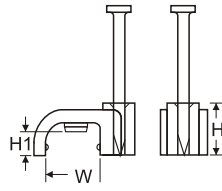

NFP-2.1

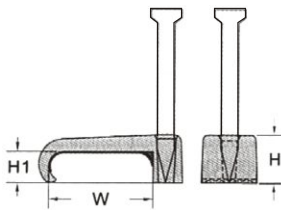

NFD-0508GY
NFD-0610GY

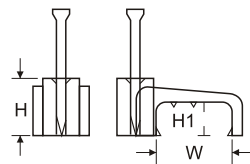

NF-2.8S

ITEM NO.	W	H	H1	SUITABLE WIRES	NAILS	PACKING.
NF-0.25	2.1	4.5	1.2	=	1.65x15	100pcs
NF-0.7	5.5	5.5	3.1	=	2.0x15	
NF-1.2	6.2	5.4	3.8	=	2.0x15	
NF-1.4	6.4	5.7	4.1	=	2.0x25	
NF-1.6	8.0	8.0	5.0	1.6 mm T&E	2.0x15	
NF-2.0S	8.5	8.0	5.2	2.0 mm T&E	2.0x25	
NF-2.2S	10.0	10.0	6.5	2.0 mm T&E	2.0x25	
NF-2.3	10.2	8.0	4.6	=	2.0x25	
NF-2.6S	11.9	9.6	6.2	6 mm T&E	2.0x25	
NF-2.8S	15.0	11.0	6.8	4 mm T&E	2.0x25	
NFT-1.5	9.8	6.7	4.4	1.5mm ² 3core&earth	2.0x25	
NFT-4.0	11.6	9.7	6.4	4 mm ² T&E	2.0x25	
NFD-1.0	16.8	7.2	4.4	1.5/1.0mm ² Double T&E	2.0x25	
NFP-2.1	9.3	8.7	4.0	1&1.5mm T&E	2.0x25	
NF-2.0	8.5	8.0	5.2	2.0mm T&E	2.5x18	
NF-2.2	10.0	10.0	6.5	2.0mm T&E	2.5x18	
NF-2.6	13.5	11.6	8.1	6mm T&E	2.5x22	
NF-2.8	15.0	12.8	8.7	=	2.5x22	
NF-3.0	18.0	12.9	9.5	10mm T&E	2.5x27	
NF-3.2	19.0	14.2	11.1	=	2.5x27	
NFT-16	20.2	13.2	10.1	16.0mm ² T&E	2.5x35	
NFD-0508GY	15.1	7.0	4.5	=	2.5x25	
NFD-0610GY	19.2	8.4	5.3	=	2.5x25	
NF-1122	21.1	14.5	11.3	2.5mm ² Double T&E	2.5x35	
NFD-2.5	20.8	14.5	11.0	2.5mm ² Double T&E	2.5x30	
NF-5.0	49.0	33.0	26.0	=	4.0x50	50pcs

DOUBLE NAIL FLAT CABLE CLIP

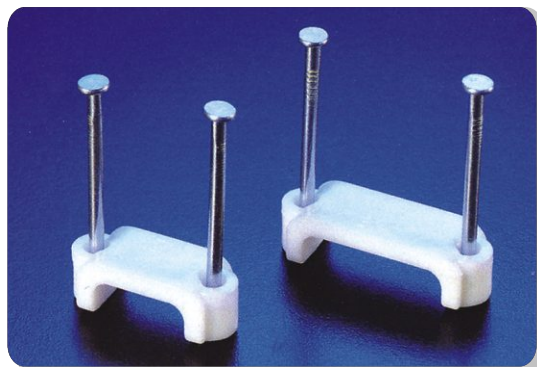

- Material: High impact PE.
- Color: White (others available upon request).
- Feature: Double nails ensure cable firmly in place.
- With steel nails inserted, steel nails for masonry.

Unit:mm

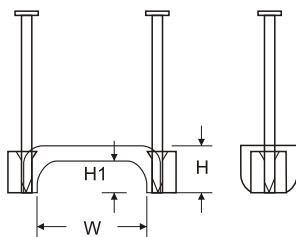

ITEM NO.	W	H	H1	SUITABLE WIRES	NAILS	PACKING.
NDF-13	12.5	8.0	5.3	#14/2, 14/3, 12/2	1.86x31	100pcs
NDF-17	17.7	14.7	11.5	=	2.0x44	
NDF-19	18.7	8.0	5.3	#12/3, 10/2, 10/3	1.86x31	
NDF-24	24.0	17.1	13.6	=	2.0x44	50pcs
NDF-37	36.8	26.1	22.5	=	2.3x50	

CABLE CLAMP



- MATERIAL: UL approved NYLON 66, 94V-2
- ELECMIT CABLE CLAMPS are designed to hold cables, tubes, and components in domestic appliance, electronics and electric apparatus generally.
- Interior edges are smoothed to protect cable insulation.
- To apply, just clamp down on loosen cables and screw it to chassis.
- Color Natural.(Black available upon request)

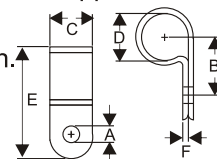

Unit:mm

Nylon Cable Tie, Wiring Accessories

ITEM NO.	A	B	C	D	E	F	PACKING
UC-0	4.8	8.0	9.6	3.1 (1/8")	17.0	1.2	100 pcs
UC-0.5	4.8	9.2	9.6	5.0 (3/16")	18.6	1.2	
UC-1	4.6	10.0	10.0	6.4 (1/4")	20.0	1.4	
UC-1.5S	4.8	11.2	10.0	7.2 (9/32")	22.6	1.5	
UC-1.5	4.6	12.0	10.0	7.9 (5/16")	22.0	1.5	
UC-2	4.6	12.5	12.0	9.5 (3/8")	24.0	1.5	
UC-3	5.0	15.2	12.0	12.7 (1/2")	31.0	1.5	
UC-4	4.6	18.2	12.0	15.8 (5/8")	34.3	1.5	
UC-5	4.6	18.2	11.8	19.4 (3/4")	35.0	1.5	
UC-6	4.6	22.0	12.0	25.4 (1")	43.0	1.8	
UC-6.5	4.6	24.0	12.0	27.5 (1 1/16")	50.0	1.8	
UC-7	4.6	26.2	12.0	31.8 (1 1/4")	46.2	1.8	
UC-9	4.6	30.0	12.0	36.7 (1 1/2")	50.0	1.8	

Quick Fitting, Terminal, Copper Tube Terminal

CABLE CLAMP (SELF-ADHESIVE)

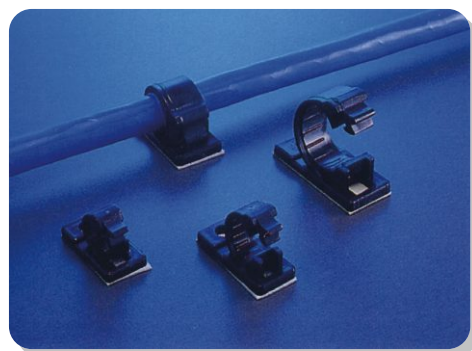

Unit:mm

ITEM NO.	DIMENSION						PACKING
	ØA	ØB	T	L	W	H	
4J-S	5.5	5.0	3.0	25.8	13.4	12.2	100pcs
6J-S	7.5	5.0	3.2	28.8	13.4	14.5	
8J-S	12.0	5.3	3.0	34.8	16.5	18.5	
10J-S	14.0	5.0	3.2	36.5	16.4	19.5	
11J-S	15.0	5.0	2.7	38.2	16.0	20.3	
12J-S	17.0	4.8	3.1	41.3	15.6	25.0	

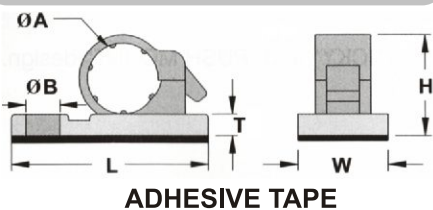

ADHESIVE TAPE

- Material: UL approved NYLON 66, 94V-2
- Color: Black
- Backed with a high quality tape. Designed to secure wire bundles where fixing holes are impractical. Can be quickly arranged bundle of wires on any clean, smooth and grease-free surface. (Also provided with a mounting hole)

Crimping Tool, Hydraulic Tool

CABLE CLAMP (ADJUSTABLE)

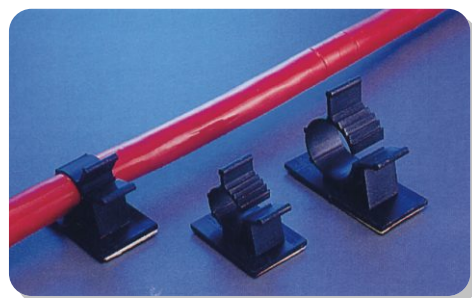

Unit:mm

ITEM NO.	ØA	B	C	D	E	F	PACKING
AP-0810	7.9~10.3	25.4	22.2	19.1	1.6	10.2	100pcs
AP-1013	10.0~12.5	31.8	27.8	19.1	1.6	10.2	
AP-1316	12.6~15.4	37.0	31.8	18.4	3.0	12.1	
AP-1720	16.5~20.1	42.0	37.0	25.0	3.0	12.7	
AP-2225	22.2~25.4	41.8	43.5	21.5	3.0	11.3	

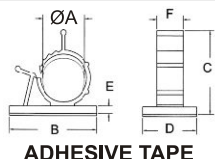

ADHESIVE TAPE

- Material: UL approved NYLON 66, 94V-2
- Color: Black
- One size of adjustable clamp can accommodate various cables that will save your cost stock.
- Easy to install, open for unlimited usage.

CABLE CLAMP

Unit:mm

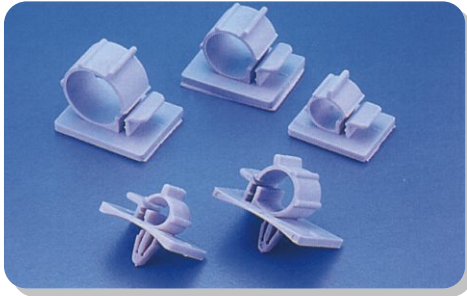

ITEM NO.		ØA	B	C	PACKING
ADHESIVE	PUSH				
TS-0607	PTS-0607	6~7	20.0	25.0	100pcs
TS-0708	PTS-0708	7~8	20.0	25.0	
TS-0910	PTS-0910	9~10	24.5	30.0	
TS-1214	PTS-1214	12~14	24.5	30.0	
TS-1618	PTS-1618	16~18	24.5	30.0	

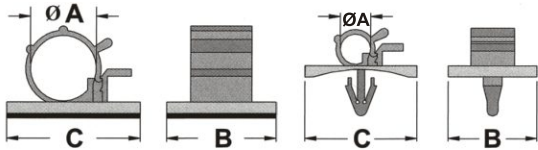

TS-TYPE (ADHESIVE)

PTS-TYPE (CHASSIS HOLE Ø4.8 PUSH)

- Material: UL approved NYLON 66, 94V-2
- Color: Gray (Other colors upon request.)
- Two stage lock designs to accommodate different cable size in one clamp.
- Same clamp available in both "STICKY" and "PUSH MOUNT" design upon request.

CONNECTOR SLEEVE (MALE)

Unit:mm

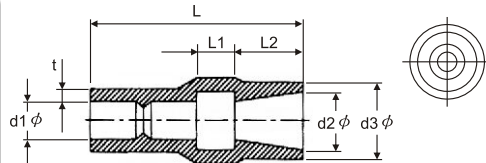

Packing unit: 1,000 pcs per bag							
ITEM NO.	d1Ø	d2Ø	d3Ø	L1	L2±0.5	L±1.5	t±0.2
R4225	2.5	3.8	5.0	2.5	4.5	14.0	1.0
R4228	2.7	3.7	5.0	2.8	4.5	13.0	1.0
R4235	3.5	4.4	5.3	3.0	4.5	16.0	1.0

CONNECTOR SLEEVE (FEMALE)

Unit:mm

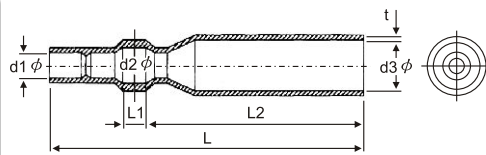

Packing unit: 1,000 pcs per bag							
ITEM NO.	d1Ø	d2Ø	d3Ø	L1	L2±0.5	L±1.5	t±0.2
R5025	2.5	3.8	5.0	2.6	23.0	33.0	1.0
R5028	2.8	4.0	5.0	2.8	23.0	33.0	1.0
R5035	3.5	4.5	5.2	3.0	23.0	33.0	1.0

250 FLAT TYPE SLEEVE (MALE)

Unit:mm

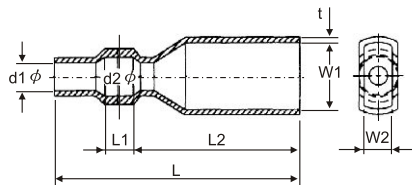

Packing unit: 1,000 pcs per bag								
ITEM NO.	d1Ø	d2Ø	L1	L2±0.5	L±1.5	W1	W2	t±0.2
S9528	2.8	3.8	3.0	16.0	27.5	9.5	5.0	1.0
S9535	3.5	4.6	3.0	16.0	26.0	9.5	5.0	1.0
S9540	4.0	5.0	3.0	16.0	26.0	9.5	5.0	1.0

250 FLAT TYPE SLEEVE (FEMALE)

Unit:mm

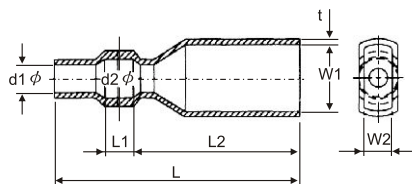

Packing unit: 1,000 pcs per bag								
ITEM NO.	d1Ø	d2Ø	L1	L2±0.5	L±1.5	W1	W2	t±0.2
S8028	2.8	4.0	3.0	17.0	26.0	7.8	3.6	1.0
S8035	3.5	4.5	3.2	17.0	27.0	7.8	3.5	1.0
S8040	4.1	5.1	3.2	17.0	27.0	8.0	3.6	1.0

HEAT SHRINKING SLEEVE

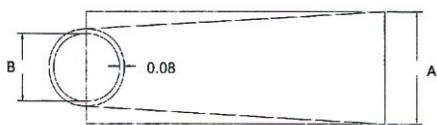
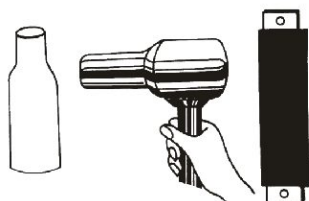

- Material: Rigid shrinkable PVC
- Used for color distinction and insulation of busbar in control panel. To be shrunk by blower or hot water.
- Maximum service temperature: 80°C.
- RD:Red WE:White BE:Blue BK:Black.

Unit:mm

ITEM NO.	LAY FLAT DIMENSION (A)	CONVERT TO DIA Ø (B)	SHRINKABLE RANGE	COLOR	RACKING
HS-6.5	6.5	4.1	6.5-3.6	RED WHITE BLUE BLACK (YELLOW GREEN UPON REQUEST)	100M / ROLL
HS-8.5	8.5	5.2	8.5-4.5		
HS-12	12	7.6	12-6.5		
HS-15	15	10	15-5.8		
HS-20	20	13	20-11		
HS-30	30	19	30-16		
HS-40	40	25	40-22		
HS-50	50	32	50-28		
HS-60	60	38	60-33		
HS-70	70	44	70-37		
HS-80	80	50	80-42		
HS-100	100	63	100-55		
HS-120	120	76	120-65		
HS-150	150	95	150-90		
HS-170	170	108	170-94		
HS-200	200	127	200-110		

Nylon Cable Tie, Wiring Accessories

Quick Fitting Terminal, Copper Tube Terminal

Crimping Tool, Hydraulic Tool

HEAT-SHRINKABLE TUBE



Unit:mm

- Material: Polyolefin
- Standard color: Black. Other colors upon request.
- Environment protection.
- Different length upon request
- Feature: Insulation of wire harness, terminals, capsule of electronic components.

ITEM NO.	AS SUPPLIED		AFTER SHRINKAGE		PACKING	
	125°C UL CSA	Inside diameter (min.)	Wall thickness (nominal)	Inside diameter (max.)		Wall thickness (nominal)
F32-1		1.3±0.2	0.2	0.5	0.33	200M/ROLL
F32-1.5		2.0±0.2	0.2	0.75	0.36	
F32-2		2.5±0.2	0.2	1.0	0.44	
F32-2.5		3.0±0.2	0.2	1.25	0.44	
F32-3		3.5±0.3	0.25	1.5	0.44	
F32-3.5		4.0±0.3	0.25	1.75	0.44	
F32-4		4.5±0.3	0.25	2.0	0.44	100M/ROLL
F32-5		5.4±0.3	0.25	2.5	0.56	
F32-6		6.4±0.4	0.25	3.0	0.56	
F32-7		7.4±0.4	0.25	3.5	0.56	
F32-8		8.4±0.4	0.25	4.0	0.56	
F32-9		9.4±0.4	0.25	4.5	0.56	
F32-10		10.4±0.4	0.25	5.0	0.56	50M/ROLL
F32-11		11.4±0.4	0.25	5.5	0.56	
F32-12		12.4±0.4	0.25	6.0	0.56	
F32-13		13.5±0.4	0.30	6.5	0.69	
F32-14		14.5±0.4	0.30	7.0	0.69	
F32-15		15.5±0.5	0.30	7.5	0.69	
F32-16		16.8±0.5	0.30	8.0	0.69	
F32-18		18.7±0.5	0.35	9.0	0.77	
F32-20		21.2±0.6	0.35	10.0	0.77	
F32-22		23.2±0.6	0.40	11.0	0.77	
F32-25		26.1±0.8	0.40	12.5	0.87	
F32-28		29.5±1.0	0.45	14.0	0.87	
F32-30		32.0±1.0	0.5	15.0	0.87	
105°C UL						
FZ-35		37.0±1.0	0.5	17.5	0.87	30M/ROLL
FZ-40		43.0±1.5	0.5	20.0	0.97	
FZ-50		53.0±2.0	0.5	25.0	0.97	
FZ-60		60min.	0.55	30.0	1.07	
FZ-80		80min.	0.6	40.0	1.17	
FZ-100		100min.	0.6	50.0	1.17	

HEAT-SHRINKABLE TUBE WITH INNER GLUE

Unit:mm



ITEM NO. 125°C UL CSA	Size (inch)	AS SUPPLIED		AFTER SHRINKAGE		
		I.D.(min)	Wall	I.D.(min)	Wall	Inside
W3F2-1/8	1/8	3.2	0.35	0.6	0.95	0.35
W3F2-3/16	3/16	4.8	0.45	1.5	1.1	0.6
W3F2-1/4	1/4	6.4	0.45	2.0	1.2	0.65
W3F2-3/8	3/8	9.5	0.50	3.0	1.3	0.65
W3F2-1/2	1/2	12.7	0.55	4.0	1.4	0.75
W3F2-3/4	3/4	19.1	0.65	8.0	1.6	0.8
W3F2-1	1	25.4	0.75	10.2	1.9	0.8

- Material: Polyolefin with glue.
- Recognition: Recognized under UL224 and CSA standard, rating voltage 600V, and 125°C
- Application of water-proof, anticorrosion and protection on different cable connection.
- Length: 1.22M
- Color: Black

HEAT-SHRINKABLE TUBE WITH INNER GLUE

Unit:mm



ITEM NO.	D		W
	AS SUPPLIED (min)	AFTER SHRINKAGE (max)	Thickness (nominal)
SCM-04	10.2	3.8	1.5
SCM-07	19.0	5.6	2.0
SCM-11	28.0	9.5	2.0
SCM-13	33.0	10.2	2.0
SCM-15	38.1	12.7	2.3
SCM-17	44.0	14.0	2.3
SCM-20	52.0	18.2	2.3
SCM-27	70.0	25.5	2.3
SCM-35	90.0	30.0	2.5
SCM-50	125.0	40.0	2.5

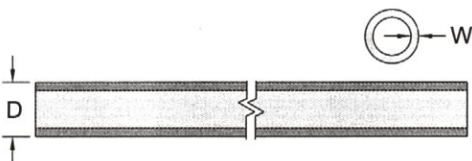

- Material: Polyolefin with glue.
- Heavy duty sleeve with glue inside for water proof.
- Application outdoor. Good for CATV cable wiring outdoor.
- Length: 1.22M
- Color: Black.

MOVABLE BUSHING

Unit:mm

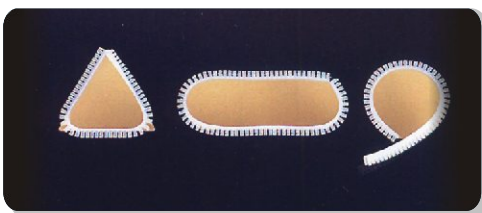

- Material: PP / NYLON (Natural Color)
- Cut to fit any hole sizes for protecting cords, wires, cables against damage from sharp panel edges.
- Flexible, high adhesion, smooth surface

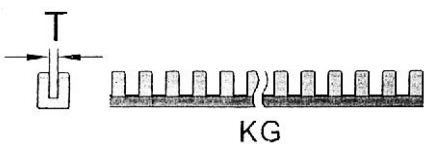

ITEM NO.	T	Max. Chassis Thickness	Packing	Material
KG-008	0.8	Under 0.8	10M/bag	PP
KG-010	1.0	1.0		
KG-012	1.2	1.0~1.2		
KG-016	1.6	1.0~1.6		
KG-020	2.0	1.6~2.0		
KG-024	2.4	2.0~2.4		
KG-032	3.2	2.4~3.2		
KG-045	4.5	3.2~4.5		
KG-010N	1.0	under 1.0	25cm/pcs	Nylon
KG-016N	1.6	1.0~1.6		
KG-020N	2.0	1.6~2.0		
KG-024N	2.4	2.0~2.4		
KG-032N	3.2	2.4~3.2		
KG-045N	4.5	3.2~4.5	100pcs/bag	

Nylon Cable Tie, Wiring Accessories

Quick Fitting, Terminal, Copper Tube Terminal

Crimping Tool, Hydraulic Tool

SNAP BUSHING

Unit:mm

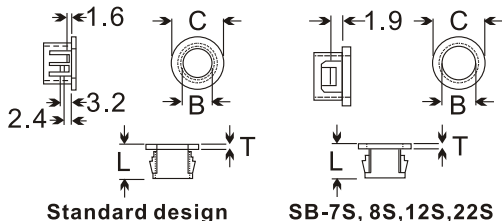

- Material: UL approved NYLON 66, 94V-2
- Color: Black
- ELECMIT SNAP BUSHING smooth and insulate your raw-edged holes in metal chassis.
- Locking into hole firmly with fingertip pressure. • Protect electrical cables, ropes, utility lines through metal holes.
- Available in application for chassis thickness form 0.8mm to 3.2mm.

ITEM NO.	Length		B	C	L	T	Packing
	mm	inch					
SB-7S	7.1	9/32"	5.8	8.8	6.1	1.3	100pcs
SB-8S	7.9	5/16"	6.8	9.8	6.0	1.5	
SB-12S	11.9	15/32"	9.2	13.7	6.3	1.5	
SB-22S	22.2	7/8"	19.6	24.0	6.5	1.5	
SB-8	7.9	5/16"	5.8	10.5	8.0	1.6	
SB-8A	7.9	5/16"	5.1	10.3	8.0	1.6	
SBP-8	7.4	=	5.9	10.8	15.0	2.0	
SB-10	9.5	3/8"	6.4	12.0	10.3	1.6	
SB-10M	9.5	3/8"	7.8	13.0	10.5	1.6	
SB-13	12.7	1/2"	8.0	15.0	10.3	1.6	
SB-14	14.3	9/16"	11.4	17.0	10.3	1.5	
SB-16	15.9	5/8"	12.7	18.6	10.3	1.6	
SB-19	19.1	3/4"	14.3	21.7	10.3	1.6	
SB-19M	19.1	3/4"	15.8	21.7	10.3	1.6	
SB-20	20.0	=	15.9	22.4	10.0	1.4	
SB-22	22.2	7/8"	17.5	24.2	11.5	1.6	
SB-22M	22.2	7/8"	18.9	24.2	11.5	1.6	
SB-25	25.4	1"	19.5	28.5	11.7	1.8	
SB-26	25.8	=	19.1	28.5	11.5	1.6	
SB-30	30.1	1 3/16"	24.1	33.3	11.5	1.6	
SB-32	32.0	=	23.8	34.6	11.4	1.5	
SB-38	38.1	1 1/2"	29.0	42.1	11.4	1.5	
SB-45	44.5	1 3/4"	35.4	47.8	11.6	1.5	
SB-50	50.8	2"	41.6	54.6	11.8	1.6	

HOLE PLUG

Unit:mm

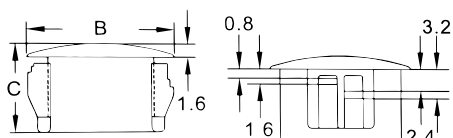
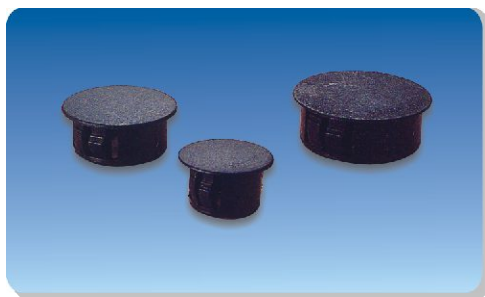

ITEM NO.	Length		B	C	Packing
	mm	inch			
HP-5	5.0	=	6.3	5.9	100pcs
HP-6	6.0	=	7.8	7.8	
HP-8	7.9	5/16"	10.3	8.1	
HP-10	9.5	3/8"	13.0	10.5	
HP-13S	12.7	1/2"	14.5	10.1	
HP-13	12.7	1/2"	16.5	10.9	
HP-15	14.3	9/16"	16.7	10.3	
HP-16	15.9	5/8"	19.5	10.0	
HP-19	19.1	3/4"	22.9	10.0	
HP-22	22.2	7/8"	25.8	11.3	
HP-25	25.4	1"	29.0	11.6	
HP-30	30.1	1 3/16"	34.2	12.0	
HP-38	38.1	1 1/2"	42.1	11.2	
HP-45	44.5	1 3/4"	49.7	11.8	

- Material: UL approved NYLON 66, 94V-2
- Color: Black
- ELECMIT HOLE PLUG close your unneeded holes with fingertip pressure at low cost and assure good appearance.
- Available in application for chassis thickness from 0.8mm to 3.2mm

GROMMET(OPEN/CLOSE)

Unit:mm



Material: PVC (Black)
 ※Available with soft type upon request, please add "Q" to item no. as GMQ-0603 / GMCQ-0603

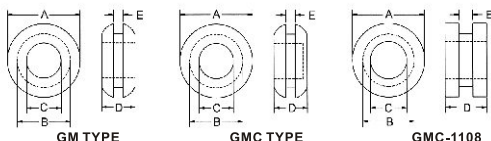

ITEM NO.		A	B	C	D	E	Packing
OPEN	CLOSE						
GM-0603	GMC-0603	8.5	6.0	3.0	4.7	1.7	100pcs
GM-0705	GMC-0705	10.2	7.2	5.0	4.4	1.7	
GM-1006	GMC-1006	13.3	10.0	6.4	6.3	1.7	
GM-1108	GMC-1108	15.5	11.0	7.8	9.0	3.0	
GM-1410	GMC-1410	19.5	13.9	10.5	6.4	3.4	
GM-2015	GMC-2015	23.7	20.1	15.5	6.1	1.7	
GM-2518	GMC-2518	29.9	25.1	18.9	7.2	1.5	
GM-3225	GMC-3225	38.1	31.7	25.0	7.8	1.5	
GMQ-0603	GMCQ-0603	8.5	6.0	3.0	4.7	1.7	
GMQ-0705	GMCQ-0705	10.2	7.2	5.0	4.4	1.7	
GMQ-1006	GMCQ-1006	13.3	10.0	6.4	6.3	1.7	
GMQ-1108	GMCQ-1108	15.5	11.0	7.8	9.0	3.0	
GMQ-1410	GMCQ-1410	19.5	13.9	10.5	6.4	3.4	
GMQ-2015	GMCQ-2015	23.7	20.1	15.5	6.1	1.7	
GMQ-2518	GMCQ-2518	29.9	25.1	18.9	7.2	1.5	
GMQ-3225	GMCQ-3225	38.1	31.7	25.0	7.8	1.5	

Nylon Cable Tie, Wiring Accessories

Quick Fitting Terminal, Copper Tube Terminal

Crimping Tool, Hydraulic Tool

STRAIN RELIEF BUSHING



- Material: UL approved Nylon 66, 94V-2
- Color: Black
- Save cuts assembly cost, prolongs cords life. Used extensively for protecting cords of computer, apparatus...etc.

CORD ASSEMBLY

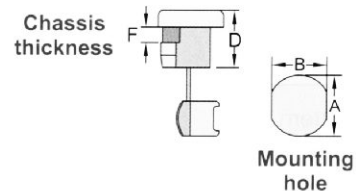
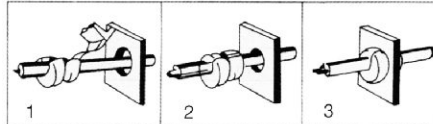

Unit:mm

ITEM NO.	Cross Section Shape	Wires Accommodate		Mounting Hole		Part L. D	Available Thickness F	Packing	
		UL Wire	Size	A	B				
SR-F21	Flat	SPT-1 #18	2.3x4.5 / 2.8x5.3	9.5	8.7	10.3	0.5-1.6	100 pcs	
SR-F23		SPT-1 #18	2.3x4.5 / 2.8x5.3	9.5	8.7	10.3	1.8-3.2		
SR-F31		SPT-1 #18	3.0x5.6	11.2	9.9	10.3	1.0-1.6		
SR-F32		SPT-1 #18	3.0x5.6	11.0	9.9	10.3	1.9-2.5		
SR-F41		SPT-2 #18	3.0x7.1 / 3.8x7.6	12.7	11.8	10.3	0.5-1.6		
SR-F42		SPT-2 #18	3.0x7.1 / 3.8x7.6	12.7	11.8	10.3	1.8-2.5		
SR-F51		SPT-3 #18	5x10.4	14.3	12.9	15.2	0.5-1.6		
SR-F53		SPT-3 #18	5x10.4	14.3	12.9	15.2	1.8-3.5		
SR-F83				6x15.2	21.6	21.3	20.4		2.0-3.4
SR-5R1		Round	SVI,SVT 3C #18	Ø6.2~Ø7.4	12.8	11.5	11.0		0.5-1.6
SR-5R2	SVI,SVT 3C #18		Ø6.2~Ø7.4	13.0	11.5	11.0	1.8-2.5		
SR-6W2	SJT 3C #18		Ø7.6	12.8	11.8	11.0	1.8-2.3		
SR-6P1	SJT 3C #18		Ø7.4~Ø8.2	15.9	14.0	14.8	0.5-1.6		
SR-6P3	SJT 3C #18		Ø7.4~Ø8.2	15.9	14.0	14.8	1.9-3.2		
SR-6R1	SJ,SJT,3C #16		Ø8.2~Ø9.2	15.9	14.0	14.8	0.5-1.6		
SR-6R3	SJ,SJT,3C #16		Ø8.2~Ø9.2	15.9	14.0	14.8	1.9-3.2		
SR-7R1	SJT 3C #14		Ø9.2~Ø10.5 / Ø11	15.9	17.0	19.0	0.5-1.6		
SR-7R3	SJT 3C #14		Ø9.2~Ø10.5 / Ø11	19.7	17.0	19.0	1.9-3.2		
SR-8R3	SJT 3C #12		Ø12~Ø15.2	21.6	21.3	20.6	1.9-3.2		
SR-9R1	# 18 20-30pec		Ø11~Ø15	15.0	19.0	17.5	0.5-1.6		
SR-9R7	SJT 3C #10		Ø15.2~Ø16.3 / Ø17.5	28.0/30.2	25.5	25.2	1.0-3.2		

Nylon Cable Tie, Wiring Accessories

Quick Fitting, Terminal, Copper Tube Terminal

Crimping Tool, Hydraulic Tool

PVC ELECTRICAL INSULATING TAPE



PVC ELECTRICAL INSULATING TAPE

- Item No: 332-CC
- Material: PVC
- Features & Uses:
 - * PVC flame retardant, weather resistant.
 - * Temperature range -10°C~80°C
 - * Thickness(mm): 0.19
 - * Adhesion(kg/25mm): 0.45 ↑
 - * Tensile-strength(kg/25mm): 7 ↑
 - * Elongation(%): 180 ↑
 - * Dielectric Breakdown(V): 7000 ↑
 - * Color: Black , Red , White , Blue , Yellow , Green , Gray.
 - * Length:20 Yard. 20M available upon request.

NYLON CABLE GLAND

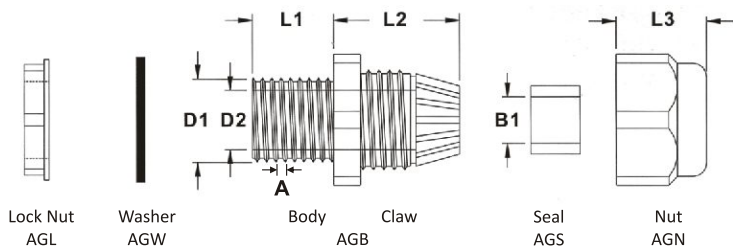

- Material : UL approved NYLON 66, 94V-2.
- Color:Black. (Other colors upon request.)

Unit:mm

METRIC THREAD

ITEM NO.	MOUNTING HOLE D1	A	D2	B1	L1	L2	L3	CABLE RANGE	PACKING
AG-12	12	1.5	8.3	6.9	7.9	19.6	13.6	3~6.5	50pcs
AG-12L	12		8.3	6.9	7.9	19.6	13.6	3~6.5	
AG-16	16		10.9	9.6	15.5	23.4	16.9	5~10	
AG-20S	20		15.0	14.8	10.0	28.5	18.5	10~14	
AG-20	20		15.0	14.8	15.0	28.5	18.5	10~14	
AG-25	25		18.6	18.4	15.2	29.4	22.3	13~18	
AG-32	32		26.0	25.0	14.7	34.5	25.7	18~25	25pcs
AG-40	40		33.7	33.0	18.4	41.7	31.3	22~32	10pcs
AG-50	50		41.9	40.0	17.8	44.2	31.3	30~38	
AG-63	61		55.0	44.0	18.5	44.6	32.7	34~44	
AG-63M	63		54.9	44.0	18.5	44.6	32.7	34~44	
AG-63L	63		56.6	51.5	25.4	49.0	36.8	42~50	

Nylon Cable Tie, Wiring Accessories

Quick Fitting Terminal, Copper Tube Terminal

Crimping Tool, Hydraulic Tool

NYLON CABLE GLAND (WITH STRAIN RELIEF)

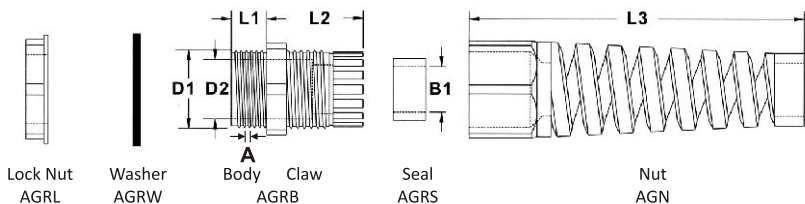

Strain relief design protect cable from breakage / right angle bending

- Material : UL approved NYLON 66, 94V-2.
- Color:Black. (Other colors upon request.)

Unit:mm

ITEM NO.	MOUNTING HOLE D1	A	D2	B1	L1	L2	L3	CABLE RANGE	PACKING
METRIC THREAD									
AG-12SR	12.0	1.25	8.3	6.9	7.9	19.6	53.3	3~6.5	50pcs
AG-16SR	16.0	1.5	10.9	10.5	15.5	23.4	74.4	5~10	
AG-20SR	20.0	1.5	15.0	14.0	15.0	28.5	96.2	10~14	
AG-25SR	25.0	1.5	18.6	18.4	15.2	29.4	111.2	13~18	25pcs
PG THREAD(Without washer)									
EG-7SR	12.5	=	8.3	6.9	7.9	20.0	53.3	3.5~6	50pcs
EG-9SR	15.2	=	10.5	8.0	7.9	22.0	62.5	4~8	
EG-11SR	18.3	=	13.2	10.5	7.9	23.7	74.9	5~10	
EG-13.5SR	20.4	=	15.5	12.0	8.9	24.6	85.5	6~12	
EG-16SR	22.5	=	17.2	14.0	9.8	26.2	96.2	10~14	
EG-21SR	28.3	=	22.4	18.4	10.8	30.0	111.2	13~18	25pcs
JIS THREAD(G)									
AGJ-14SR	14.0	=	8.2	6.5	8.0	19.6	53.3	3~6.5	50pcs
AGJ-17SR	17.0	=	10.8	10.3	14.7	23.5	74.9	5~10	
AGJ-21SR	21.0	=	14.9	14.0	12.9	28.3	96.2	10~14	
AGJ-27SR	27.0	=	18.5	18.0	14.7	29.1	111.2	13~18	

※EG-SR SERIES (WITHOUT WASHER)

NYLON CABLE GLAND

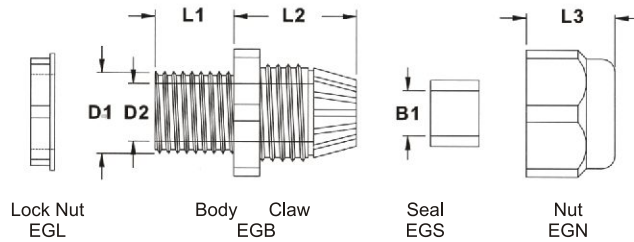

- Material : UL approved NYLON 66, 94V-2.
- Color:Black. (Other colors upon request.)

PG THREAD (DIN STANDARD) WITHOUT WASHER

Unit:mm

ITEM NO.	PG THREAD	D1	D2	B1	L1	L2	L3	CABLE RANGE	PACKING
EG-7	PG-7	12.5	8.3	6.9	7.9	20.0	13.3	3.5-6	50pcs
EG-7LS	PG-7	12.5	8.3	6.9	7.9	20.0	13.3	3.5-6	
EG-9	PG-9	15.2	10.5	8.0	7.9	22.0	15.1	4-8	
EG-9L	PG-9	15.2	10.5	8.0	14.7	22.0	15.1	4-8	
EG-11	PG-11	18.6	13.2	10.5	7.9	23.7	18.3	5-10	
EG-11L	PG-11	18.6	13.2	10.5	14.9	23.7	18.3	5-10	
EG-13.5	PG-13.5	20.4	15.5	12.0	8.9	24.6	18.9	6-12	
EG-13.5L	PG-13.5	20.4	15.5	12.0	15.8	24.6	18.9	6-12	
EG-16	PG-16	22.5	17.2	14.0	9.8	26.2	19.5	10-14	
EG-21	PG-21	28.3	22.4	18.4	10.8	30.0	23.7	13-18	
EG-29	PG-29	37.0	30.6	25.0	10.8	35.0	27.4	18-25	25pcs
EG-36	PG-36	47.0	35.3	35.5	14.5	42.3	30.3	22-32	10pcs
EG-42	PG-42	54.0	40.0	40.0	14.5	44.0	31.2	30-38	
EG-48	PG-48	59.3	46.2	46.0	15.6	42.7	31.3	34-44	

NYLON CABLE GLAND

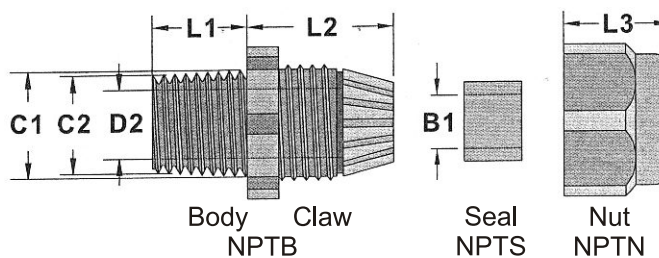

※Available for Lock Nut and washer upon request

- Material : UL approved NYLON 66, 94V-2.
- Color:Black. (Other colors upon request.)

NPT THREAD

Unit:mm

ITEM NO.	EXTERNAL THREAD		NPT THREAD	D2	B1	L1	L2	L3	CABLE RANGE	PACKING
	C1	C2								
NPT-14	13.2	13.1	1/4"-18NPT	8.2	6.9	7.8	19.7	13.2	3-6.5	50 pcs
NPT-38	16.7	16.2	3/8"-18NPT	10.8	10.5	14.6	23.8	16.8	5-10	
NPT-12	21.2	20.8	1/2"-14NPT	14.9	14.0	12.9	28.4	18.7	10-14	
NPT-34	26.3	25.6	3/4"-14NPT	18.5	18.4	14.5	29.2	22.3	13-18	
NPT-1	33.2	32.9	1"-11.5NPT	26.0	25.0	14.9	35.0	25.7	18-25	25 pcs
NPT-114	41.9	41.2	1 1/4"-11.5NPT	32.0	33.0	18.2	41.6	31.4	22-32	10 pcs

FLEXIBLE CONDUIT ADAPTOR

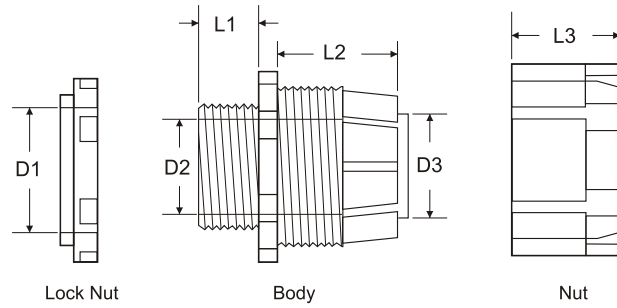
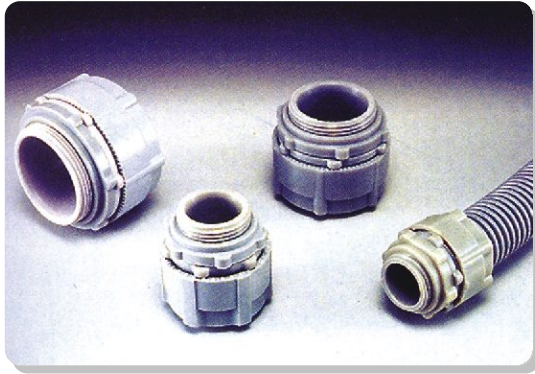

Nylon Cable Tie, Wiring Accessories

Quick Fitting, Terminal, Copper Tube Terminal

Crimping Tool, Hydraulic Tool

- Material: UL approved NYLON 66, 94V-2(Gray)
- Constructed of three parts to fix flexible conduit in control panel, machinery and apparatus.
- Application:
 1. Mount body to pre-drilled panel hole.
 2. Insert conduit through nut.
 3. Insert conduit to claw and fix it with nut to complete works.

Unit:mm

ITEM NO.	D1	D2	D3	L1	L2	L3	CONDUIT SUITABLE	PACKING
BG-10	14.4	6.3	7.5	9.7	18.5	15.9	BG-10P	50pcs
BG-16	15.9	11.0	10.8	10.0	17.9	15.7	BG-16P	
BG-18	16.0	11.1	13.3	9.7	18.6	15.9	BG-18P	
BG-20	20.0	15.0	14.7	10.0	17.7	16.0	BG-20P	
BG-22	20.0	15.4	17.2	9.8	17.6	16.3	BG-22P	
BG-25	23.1	18.0	19.6	11.3	23.4	21.0	BG-25P	
BG-26	25.0	18.9	19.8	11.4	23.6	20.6	BG-26P	25pcs
BG-32	31.2	26.0	24.3	12.0	22.8	20.6	BG-32P	
BG-34	32.0	26.8	28.6	11.3	23.3	20.7	BG-34P	
BG-40	37.5	31.5	31.6	11.3	23.6	20.7	BG-40P	
BG-42	40.0	32.7	34.8	11.5	23.3	20.8	BG-42P	10pcs
BG-48	44.0	37.5	40.5	12.6	22.3	20.7	BG-48P	
BG-50	44.0	37.5	39.5	12.6	21.6	20.7	BG-50P	

FLEXIBLE CONDUIT

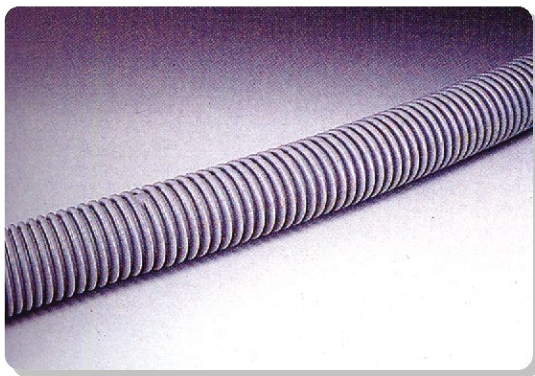

- Material: PE(EVA available), color Gray .
- For running cable protection in Electrical/Machinery/Building Harness wiring.
- Flexible body facilitate your corner/elbow wiring.

Unit:mm

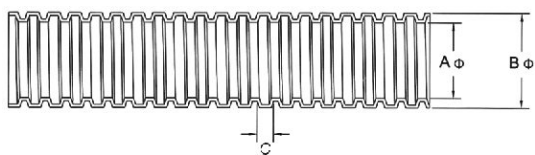

ITEM NO.	AØ	BØ	C	PACKING.
BG-10P	7.4±0.4	10.2±0.4	2.64	300M
BG-14P	10.7±0.4	14.1±0.4	2.04	100M
BG-16P	10.7±0.4	16.0±0.4	3.30	
BG-18P	13.8±0.4	17.5±0.4	3.10	
BG-20P	14.1±0.4	20.0±0.4	3.70	
BG-22P	17.2±0.4	22.0±0.4	3.10	
BG-25P	18.3±0.4	25.0±0.4	4.10	
BG-26P	21.2±0.4	25.8±0.4	3.10	50M
BG-32P	24.3±0.4	32.0±0.4	3.61	
BG-34P	28.7±0.4	34.0±0.4	3.10	
BG-40P	31.2±0.4	40.0±0.4	4.12	
BG-42P	34.9±0.4	42.0±0.4	3.10	
BG-48P	40.0±0.5	48.0±0.5	2.85	
BG-50P	39.6±0.5	50.0±0.5	4.85	
BG-55P	47.5±0.5	54.5±0.5	2.00	
BG-60P	52.0±0.5	60.0±0.5	5.80	
BG-76P	62.0±0.5	76.0±0.5	5.80	

FLEXIBLE CONDUIT

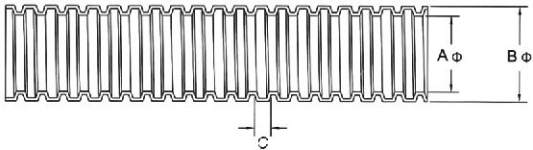

• Material: PP (BLACK)

Unit:mm

ITEM NO.		AØ	BØ	C	PACKING.
SPLIT DESIGN	CLOSE DESIGN				
CR-07P	CRS-07P	7.4±0.4	10.2±0.4	2.60	300M
CR-11SP	CRS-11SP	10.7±0.4	14.0±0.4	1.10	
CR-11P	CRS-11P	10.7±0.4	16.0±0.4	3.30	
CR-13P	CRS-13P	13.8±0.4	17.5±0.4	3.10	200M
CR-15P	CRS-15P	15.0±0.4	19.5±0.4	3.50	
CR-17P	CRS-17P	17.2±0.4	22.0±0.4	3.10	
CR-19P	CRS-19P	19.3±0.4	23.8±0.4	3.50	100M
CR-22P	CRS-22P	21.2±0.4	25.8±0.4	3.10	
CR-24P	CRS-24P	24.3±0.4	32.0±0.4	3.61	
CR-25P	CRS-25P	25.0±0.4	30.0±0.4	4.10	50M
CR-28P	CRS-28P	28.0±0.4	34.0±0.4	3.10	
CR-32P	CRS-32P	31.2±0.4	40.0±0.4	4.12	
CR-35P	CRS-35P	34.9±0.4	42.0±0.4	3.10	
CR-40P	CRS-40P	39.6±0.5	50.0±0.5	4.85	
CR-48P	CRS-48P	47.5±0.4	54.5±0.5	2.00	
CR-52P	CRS-52P	52.0±0.5	60.0±0.5	5.80	
CR-62P	CRS-62P	62.0±0.5	76.0±0.5	5.80	
CR-80P	CRS-80P	80.0±0.5	59.0±0.5	5.80	

NYLON FLEXIBLE CONDUIT

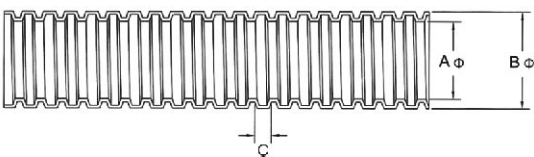

- Material: UL approved Nylon 6, 94HB (Black).
- For running cable protection in Electrical/Machinery/ Building Harness wiring.
- Flexible body facilitate your corner/elbow wiring.
- CLOSE DESIGN

Unit:mm

ITEM NO.	INCH	AØ	BØ	C	PACKING.
PA-07	1/4"	6.6±0.4	10.0±0.4	2.4	50M
PA-10	5/16"	9.8±0.4	13.0±0.4	2.0	
PA-12	3/8"	12.2±0.4	15.8±0.4	2.1	
PA-17	1/2"	16.8±0.4	21.7±0.4	2.3	
PA-23	3/4"	23.0±0.4	28.5±0.4	2.3	
PA-29	1"	28.6±0.4	34.4±0.4	2.5	
PA-36	1 1/4"	35.8±0.4	42.5±0.5	2.0	25M
PA-48	2"	47.5±0.4	54.5±0.5	2.0	



• LOW VOLTAGE INSULATOR DIMENSION

Unit:mm

ITEM NO.	A	B	C	D	E
SM-25	25	30	22.9	M6	M6
SM-35	35	32	28	M8	M8
SM-51	51	36	29	M8	M8
SM-76	76	50	36	M10	M10

For more product information, Please check our website: www.elecmit.com

METAL FLEXIBLE CONDUIT



- Material: GALVANIZED, STEEL CORE WITH PVC COATED.
- Color: Black.(Gray upon request.)

Unit:mm

ITEM NO.	I.D.		O.D. mm	CONDUIT SUITABLE	PACKING
	inch	mm			
MC-03	3/8"	10.0	14.4	MCB-03 / MCL-03	50M
MC-04	1/2"	12.8	17.5	MCB-04 / MCL-04	
MC-06	3/4"	20.2	25.58	MCB-06 / MCL-06	
MC-08	1"	26.2	32.4	MCB-08 / MCL-08	
MC-10	1 1/4"	32.5	39.0	MCB-10 / MCL-10	30M
MC-12	1 1/2"	39.3	46.2	MCB-12 / MCL-12	
MC-16	2"	51.3	59.5	MCB-16 / MCL-16	20M
MC-20	2 1/2"	62.9	72.2	MCB-20 / MCL-20	10M
MC-24	3"	77.5	88.9	MCB-24 / MCL-24	
MC-32	4"	101.6	113.9	MCB-32 / MCL-32	5M



Nylon Cable Tie, Wiring Accessories

Quick Fitting, Terminal, Copper Tube Terminal

Crimping Tool, Hydraulic Tool

METAL FLEXIBLE CONDUIT ADAPTOR

- Material:malleable iron, zinc plated.
- Suited for MC-seriesconduit.

Unit:mm

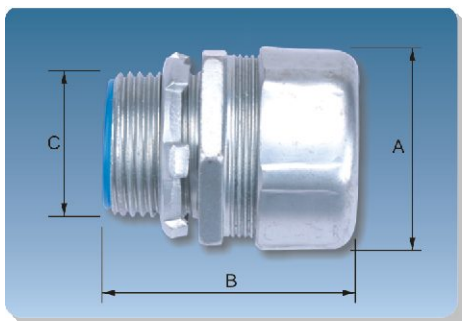

ITEM NO.	NOMINAL SIZE	DIMENSION(APPROX)				THREAD	PACKING (PCS)
		I.D.	A	B	C		
MCB-03	3/8"	11.00	27.00	38.10	21.30	NPT 1/2	100
MCB-04	1/2"	14.50	34.60	39.70	21.30	NPT 1/2	100
MCB-06	3/4"	19.50	42.00	41.30	26.70	NPT 3/4	50
MCB-08	1"	25.00	47.40	52.30	33.40	NPT 1	50
MCB-10	1-1/4"	33.50	58.00	60.50	42.20	NPT 1-1/4	25
MCB-12	1-1/2"	38.00	65.00	68.30	48.30	NPT 1-1/2	20
MCB-16	2"	49.50	78.00	80.50	60.30	NPT 2	10
MCB-20	2-1/2"	61.00	99.20	100.00	73.00	NPT 2-1/2	1
MCB-24	3"	76.00	118.30	105.00	88.90	NPT 3	1
MCB-32	4"	99.00	146.30	110.00	114.30	NPT 4	1

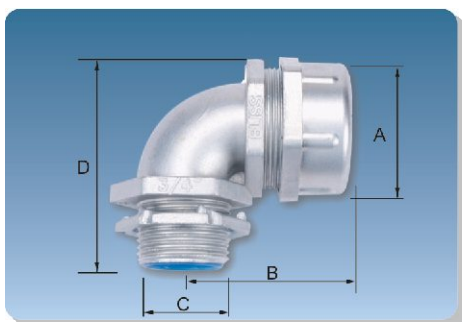

ITEM NO.	NOMINAL SIZE	DIMENSION(APPROX)					THREAD	PACKING (PCS)
		I.D.	A	B	C	D		
MCL-03	3/8"	11.00	29.00	43.00	21.30	47.00	NPT 1/2	50
MCL-04	1/2"	14.50	34.60	39.70	21.30	53.00	NPT 1/2	50
MCL-06	3/4"	19.50	42.00	55.00	26.70	60.00	NPT 3/4	50
MCL-08	1"	25.00	47.40	61.00	33.40	77.00	NPT 1	25
MCL-10	1-1/4"	33.50	58.00	75.00	42.20	81.00	NPT 1-1/4	15
MCL-12	1-1/2"	38.00	65.00	85.00	48.30	100.00	NPT 1-1/2	10
MCL-16	2"	49.50	78.00	105.10	60.30	110.00	NPT 2	5
MCL-20	2-1/2"	61.00	99.20	180.00	73.00	205.00	NPT 2-1/2	1
MCL-24	3"	76.00	118.30	200.00	88.90	235.00	NPT 3	1
MCL-32	4"	99.00	145.30	250.00	114.30	305.00	NPT 4	1